

DNB/DrNB

Final Examination

June 2022

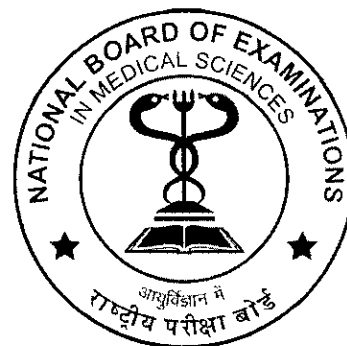

Information Bulletin

**Diplomate National Board (DNB)
(Broad Specialty)**

**Doctorate National Board (DrNB)
(Super Specialty)**

- ◆ **Final Examination (Theory & Practical)**
- ◆ **Only Practical**

IMPORTANT DATES

Processes

Timelines

Availability of Information Bulletin	29th March 2022 Onwards
Online Application Submission	29th March 2022 (3 PM Onwards) to 18th April 2022 (Till 11:55PM)
Issue of Admit Card	16th June 2022

Theory Examination Dates

DNB Final (Broad Specialty)

Paper	Day	Date	Exam Time
I	Wednesday	22-06-2022	2:00 PM-5:00 PM
II	Thursday	23-06-2022	2:00 PM-5:00 PM
III	Friday	24-06-2022	2:00 PM-5:00 PM
IV	Saturday	25-06-2022	2:00 PM-5:00 PM

DrNB Final (Super Specialty)

Paper	Day	Date	Exam Time
I	Wednesday	22-06-2022	2:00 PM-5:00 PM
II	Thursday	23-06-2022	2:00 PM-5:00 PM
III	Friday	24-06-2022	2:00 PM-5:00 PM

DrNB Super Specialty Direct 6 Years Course - Part - I

Paper	Day	Date	Exam Time
I	Wednesday	22-06-2022	2:00 PM-5:00 PM
II	Thursday	23-06-2022	2:00 PM-5:00 PM

- ❖ Candidates willing to apply for DNB/DrNB final - **ONLY PRACTICAL Examination – June 2022 session** can submit their online applications latest by **31st July 2022**.

INDEX

S.No	CONTENTS	Page Number
1	Introduction	4
2	Information for Candidates	5
3	Fee Structure	10
4	Examinations for Broad Specialties	11
5	Examinations for Super Specialties	17
6	Date of Examinations and Result	26
7	Centre for Final Examinations	30
8	Instructions to Fill Online DNB/DrNB Final Application Form	32
9	Unfair Means	40
10	Communication Protocols	45
11	Leave Rules for DNB/DrNB/FNB Trainees	47
12	Image Upload Instructions	49
13	Annexures	66

1. Introduction

The Government of India established the National Board of Examinations in Medical Sciences (NBEMS) in 1975 with the objective of improving the quality of the Medical Education by establishing high and uniform standards of postgraduate examinations in modern medicine on an all India basis and utilizing existing infrastructure for capacity building.

NBEMS at present conducts postgraduate and postdoctoral examinations in approved specialties leading to the award of Diplomate of National Board (DNB) and Doctorate of National Board (DrNB) respectively.

The Examinations conducted by NBEMS provide a common standard and mechanism of evaluation of minimum level of attainment of the knowledge and competencies of medical specialties. Moreover, intra country and international comparisons are facilitated with the availability of common evaluation mechanism.

The notification issued in the Gazette of India for qualifications awarded by National Board of Examinations in Medical Sciences are available under **Annexure - I**.

2. Information for Candidates

- 2.1. DNB/DrNB – Final is an exit examination leading to the award of DNB/DrNB qualification respectively. National Board of Examinations in Medical Sciences conduct DNB/DrNB Final Examination in June and December every year.
- 2.2. The next session of DNB/DrNB Final Theory Examination shall be held in June 2022 as per schedule detailed under Important Dates and Scheme of Examination.
- 2.3. A candidate registered with NBEMS as a DNB/DrNB trainee and obtaining requisite period of training as prescribed by NBEMS & fulfilling other eligibility criteria as stated in the Information Bulletin may appear for the DNB/DrNB final examination.
- 2.4. Candidates should go through this bulletin carefully for eligibility criteria before applying. Queries pertaining to eligibility and other issues will only be entertained if the information requested is not given in the bulletin of information or National Board of Examinations in Medical Sciences website <https://natboard.edu.in>
- 2.5. The list of specialties in which examination will be conducted can be seen at **Annexure II**
- 2.6. Candidate should ensure that all the information entered during the online submission of application form is correct and factual. Information provided by the candidates in the online application form shall be treated as correct.
- 2.7. NBEMS itself does not edit /modify/alter any information entered by the candidates at the time of online submission of application form under any circumstances. There is no provision of change in any information after conduct of examination and/or declaration of result. Such requests shall not be entertained.

-
- 2.8. Application for DNB/DrNB Final Theory Exam - June 2022 can only be submitted online through National Board of Examinations in Medical Sciences website <https://natboard.edu.in> There is no other methodology for application submission. Application submitted through any other mode shall be summarily rejected. There is no requirement to submit the hard copy print out of the application form and documents uploaded to NBEMS website.
- 2.9. Application form of candidates producing false or fabricated records will not be considered and the candidate may be further debarred from appearing in any future examinations of National Board of Examinations in Medical Sciences.
- 2.10. Candidates are advised to ensure that no mandatory column in the online application form is left blank. In the event of rejection of the application form, no correspondence/request for re-consideration will be entertained.
- 2.11. Candidates should go through this bulletin carefully for eligibility criteria before applying. Queries pertaining to eligibility and other issues will only be entertained if the information requested is not given in the bulletin of information or NBEMS website. No Queries of the Guardians/Parents/Spouse will be entertained on telephone with regard to the eligibility and disclosure of the results.
- 2.12. Candidate found ineligible at any stage of DNB/DrNB Final examination, will not be permitted to appear in the examination. In an unlikely event of any ineligible candidate appearing and/or passing the DNB/DrNB examination, the results/candidature of such candidate shall be cancelled and/or is deemed to be cancelled, even if result has been declared.
- 2.13. Candidature of candidates who are allowed to appear provisionally in the examination shall be cancelled and result, if

-
- declared, shall be treated as null and void if they fail to fulfill the eligibility criteria prescribed.
- 2.14. NBEMS reserves the right to withdraw permission, if any, granted inadvertently to any candidate who is not eligible to appear in the DNB/DrNB Final Examinations even though the admit card/roll number has been issued or name/roll number is displayed on NBEMS website.
- 2.15. Fee shall neither be carried forward to a future exams nor refunded on successful submission of application.
- 2.16. Candidates' eligibility is purely provisional & is subject to the fulfilment of eligibility criteria as prescribed by National Board of Examinations in Medical Sciences.
- 2.17. Instructions in the information-bulletin are liable to change based on decisions taken by the NBEMS from time to time.
- 2.18. NBEMS reserves its absolute rights to alter the examination schedule, pattern, policy and guidelines at any time during the continuation or after the completion of DNB/DrNB training (2 or 3 or 6 years/as the case may be). The candidate shall have no right whatsoever for claiming/deriving any right from past or present schedule, policy and guidelines of National Board of Examinations in Medical Sciences.
- 2.19. NBEMS reserves its absolute right to alter, amend, modify or apply any or some of the instructions/ guidelines contained in this information bulletin.
- 2.20. The existing schedule, pattern, policy and guidelines are for ready reference only but in no way, they are or are ought to be treated as representative or acknowledgment of fact that NBEMS is bound to follow the same in future.

-
- 2.21. In case of any ambiguity in interpretation of any of the instructions/ terms/ rules/ criteria regarding the determination of eligibility/ conduct of examinations/ registration of candidates/ information contained herein, the interpretation of the National Board of Examinations in Medical Sciences shall be final and binding in nature.
- 2.22. Request shall not be entertained for change in date/ center of examination under any circumstances. Candidates are advised not to canvass for such representation.
- 2.23. Copy of application form submitted may be retained by the candidate for future reference.
- 2.24. Admit Cards for DNB/DrNB Final Examination shall be available to download at NBEMS website <https://natboard.edu.in> from **16th June 2022 onwards**.
- 2.25. Result for DNB/DrNB Final Examinations shall be displayed on the website <https://natboard.edu.in>
- 2.26. Candidates should ensure before applying for DNB/DrNB Final Examinations that their MD/MS/DM/M.Ch/Diploma is recognized by the National Medical Commission (NMC) as per provisions of the NMC Act, 2019 and the First Schedule of the IMC Act. If it is found at any stage that the Degree/Diploma is not recognized by NMC, NBEMS will have the right to cancel the registration/examination.
- 2.27. Registration with NBEMS is mandatory for all candidates appearing in DNB/DrNB Final Examinations.
- 2.28. The applicant candidates should communicate with National Board of Examinations in Medical Sciences regarding matters

related to DNB/DrNB Final Examinations as per prescribed communication protocols detailed under Chapter on Communication Protocol.

2.29. All the correspondence through post should be addressed to the Executive Director, National Board of Examinations in Medical Sciences, Medical Enclave, Mahatma Gandhi Marg, Ansari Nagar, New Delhi-110029. Candidates are requested to superscribe the envelope with the subject matter of the correspondence for expeditious processing.

2.30. The jurisdiction for court cases/disputes shall be at New Delhi only.

3. Fee Structure

3.1. Examination Fee:

Candidate	Examination Fee (Theory & Practical)	Registration Fee	Total* (in Rs.)
DNB/DrNB Trainees	6000	Not Applicable#	6000
MD/MS or DM/MCh	6000	1000	7000
Only Practical Examination (DNB/DrNB trainee or MD/MS/DM/MCh Candidate)			6000

*Excluding payment gateway charges, as may be applicable.

Paid at the time of Registration for the DNB/DrNB Course.

- 3.2. Applications forms once submitted cannot be withdrawn. Any claim for refund, adjustment or carrying forward of Application fee will not be entertained after successful submission of application.
- 3.3. **How to pay:** The prescribed exam fee should be remitted through payment gateway provided using a Credit Card or a Debit Card issued by banks in India or other modes as may be made available and have been provided on the web page.
- 3.4. Examination fees in respect of candidates who are absent or declared ineligible due to any reason will be forfeited. Candidates are advised to read the rule position carefully and satisfy the terms and conditions for fulfilment of eligibility criteria before proceeding for payment of fees.

4. Examination for Broad Specialties

4.1. For Broad Specialties:

4.1.1.DNB Final is a two-stage examination comprising of theory and practical examination.

4.1.2.An eligible candidate who has qualified the theory examination is permitted to appear in the practical examination. Those who fail to qualify the theory examination are required to reappear in the theory examination.

4.1.3.The practical examination of the session in which the candidate qualifies the theory examination shall be the mandatory first attempt. A candidate unsuccessful in the first attempt of practical examination is permitted to undertake two more attempt(s) of practical examinations. These two attempts shall be any two practical examinations conducted in next three consecutive sessions of DNB Final Examinations.

Example: Candidates qualifying theory examination of June 2022 session shall appear for their first attempt in the practical exams of June 2022 session compulsorily and in the event of they not passing this practical examination, the candidate(s) may take any two attempts at the practical exams of next three consecutive sessions as and when conducted.

4.1.4.Absentation from Practical Examination after successful submission of application is counted as an attempt.

4.1.5.The list of Specialties in which candidates can undertake DNB Final examination are mentioned at **Annexure-II**.

4.2. Examination (Broad Specialties):

4.2.1. Theory Examination

- The theory examination comprises of four papers, maximum marks 100 each.
- There are 10 short notes of 10 marks each, in each of the papers.
- The number of short notes and their respective marks weightage may vary in some subjects/some papers.
- Maximum time permitted is 3 hours.
- Candidate must score at least 200/400 in the aggregate of 4 papers to qualify the theory examination. Grace marks of up to 2% of maximum marks i.e. 8/400 shall be given only to the candidates falling in the zone of consideration i.e. securing between 192-199 marks out of 400.
- Only those candidates who have qualified the theory examination are permitted to take the practical examination.

4.2.2. Practical Examination

- Maximum Marks: 300
- Comprises of OSCE and/or Clinical Examination, and Viva.
- Candidate must obtain a minimum of 150/300 marks to qualify for the Practical Examination.
- There is no provision for grace marks in Practical examination.
- There are a maximum of three attempts that can be availed by a candidate for Practical Examination.
- First attempt is the practical examination following immediately after the declaration of theory results in the same session.
- Second and Third attempt in practical examination shall be permitted out of the next three sessions of DNB Final Examinations; after payment of full examination fees as may be prescribed by NBEMS.

-
- Absentation from Practical Examination after successful submission of application is counted as an attempt. Appearance in first practical examination is compulsory.
 - Requests for Change in center/date of examination are not entertained, as the same is not permissible. Candidates are required not to canvass with NBEMS for above.
 - **DNB Broad Specialty trainees whose theses are not accepted by the National Board of Examinations in Medical Sciences by the time of announcement of practical examination centres shall not be allowed to appear in the practical examination.**
 - Above scheme of practical examination may vary due to ongoing COVID 19 Pandemic.

4.3. Eligibility (Broad Specialty)

4.3.1.DNB Broad Specialty Candidates (Post MBBS and Post Diploma):

- Candidates who have undergone training as a DNB trainee at any of the National Board of Examinations in Medical Sciences accredited institute after having registered with NBEMS as a DNB trainee and are completing their prescribed (as per letter of registration issued by NBEMS) training as a DNB trainee by the date mentioned below & on submission of certificate to this effect, can undertake the DNB Final Examination in the same specialty.

**Cutoff date for completion of DNB Training towards
eligibility for DNB Final Examination - June 2022**

30th November 2022

- Submission of Training Completion Certificate indicating details of leave taken during DNB training for DNB trainees is an essential pre-requisite. In case the candidate does not submit the training Completion certificate (as per applicable format given in Annexure III & IV) along with the application form, his/her application shall be rejected and fees forfeited.

-
- Request for extension in cutoff date for completion of training for the purpose of eligibility determination for DNB final Examination shall not be considered.
 - **Candidates who have completed their DNB training while applying for DNB Final Examination** shall be required to submit Final Training Completion Certificate (FTCC) as per format prescribed in Annexure - IV.
 - **Candidates whose DNB training is ongoing while applying for DNB Final Examination** shall be required to submit **Provisional Training Completion Certificate (PTCC)** as per format in Annexure-III. The PTCC must confirm that the candidate would be able to complete his/her training by the prescribed cut-off, after taking into consideration all leave taken vis-a-vis the maximum permissible leave as per NBEMS leave rules and the required period of extension, if any. Such candidates are required to submit **Final Training Completion Certificate (FTCC)** as per format in Annexure-IV **immediately on completion of their training**. Such candidates shall be provisionally allowed to appear for DNB Final Examination subject to completion of their DNB training by the prescribed cut-off date.
 - Candidates who submit their **Provisional TCC with correct leave details** projecting their training completion on/before the prescribed cut-off date for the examination, happen to avail more leave after applying for the examination due to some unforeseen reasons which might take their training beyond the prescribed cut-off date, shall NOT be declared INELIGIBLE for the examination.
 - If such a candidate qualifies the theory and practical examination, his/her Provisional Pass Certificate shall only be issued on completion of his/her DNB training and submission of Final TCC to this effect.

-
- If such a candidate qualifies theory examination but fails to qualify the practical examination, his/her candidature for theory examination shall remain valid and he/she shall be allowed to appear in the next remaining attempt(s) of practical examination, provided that he/she completes his/her DNB training before the next attempt of practical examination.
 - However, candidates who at any stage are found to have misrepresented/failed to disclose the complete details of leave taken by them, in their **Provisional TCC**, shall be declared **INELIGIBLE** on failing to complete their training on/before the prescribed cut-off date for the examination. Candidature of such candidates for DNB Final Examination shall stand cancelled and result, if any declared, shall be treated as null and void.
 - In terms of the NBEMS notice dated 26th November 2019 (published on NBEMS website <https://natboard.edu.in>), appearance in minimum required numbers of Formative Assessment Tests (FATs) during the DNB/DrNB training shall be mandatory towards eligibility for appearing in DNB/DrNB Final Examinations. This compulsory participation in FATs shall apply to candidates who have joined their training in or after July 2019 admission session.

4.3.2.MD/MS Qualified Candidates:

- Candidates who have passed the final examination, **on or before 31st March 2022**, leading to the award of a Post Graduate Degree (MD/MS), from an Indian University, which is duly recognized as per provisions of the National Medical Commission (NMC) Act, 2019 and the first schedule of the IMC Act can apply for the DNB Final examination in the same broad specialty.
- As per the MoHFW letter No. C.18018/11/2021-MEP dated 30.04.2021, the FCPS qualifications awarded by the College of Physicians and Surgeons, Mumbai are not equivalent to either

MD or MS courses. Accordingly, candidates possessing FCPS qualifications awarded by the College of Physicians and Surgeons, Mumbai are not eligible to apply for DNB Final Examinations.

- Submission of proof of having qualified final examination for MD/MS degree on or before **31st March 2022** is an essential prerequisite. In case the candidate does not submit the requisite proof of qualifying final examination for MD/MS degree by the prescribed cut-off date, his/ her candidature shall be cancelled & fees forfeited.

4.4. Thesis Submission to NBEMS

- As per NBEMS norms, writing a thesis is essential for all DNB trainees towards partial fulfilment of eligibility for award of DNB degree certificate.
- In terms of the NBEMS notice dated 06.01.2022, the last date for submission of thesis by DNB trainees who are eligible to appear in the DNB Final Theory Examination - June 2022 was notified as **28th February 2022**. DNB trainees who have failed to submit their theses to National Board of Examinations in Medical Sciences for assessment by 28th February 2022 are not eligible to apply for DNB Final Theory Examination - June 2022.
- Candidates who have failed to qualify the Final theory examination in earlier sessions are not eligible to apply for any further final theory examinations till such time their theses are accepted by NBEMS.
- The status of thesis submission/acceptance, as may be applicable, shall be verified the time of submission of online application for DNB Final Theory Examination.

5. Examination for Super Specialties

5.1. For Super Specialties:

5.1.1. DrNB Final is a two-stage examination comprising of theory and practical examination.

5.1.2. An eligible candidate who has qualified the theory examination is permitted to appear in the practical examination. Those who fail to qualify the theory examination are required to reappear in the theory examination of session.

5.1.3. The practical examination of the session in which the candidate qualifies the theory examination shall be the mandatory first attempt. A candidate unsuccessful in the first attempt of practical examination is permitted to undertake one more attempt of practical examinations. The second attempt can be taken in next two consecutive sessions of DrNB Final Examinations.

Example: Candidates qualifying theory examination in June 2022 session shall appear for their first attempt in the practical exams of June 2022 session compulsorily and in the event of they not passing this practical examination, the candidate(s) may take second attempt at the practical exams of next two consecutive sessions as and when conducted.

5.1.4. Absentation from Practical Examination after successful submission of application is counted as an attempt.

5.1.5. The list of Specialties in which candidates can undertake DrNB Final examination in are mentioned at **Annexure-II**.

5.2. Examination (Super Specialties):

5.2.1. Theory Examination

- Maximum Marks: 300

-
- The theory exam comprises of three question papers.
 - There are 10 short notes of 10 marks each in the question paper
 - The number of short notes and their respective marks weightage may vary in some subjects/some papers.
 - Maximum time permitted is 3 hours for each question paper
 - Candidate must score at least 50% of maximum marks to qualify the theory exam i.e. candidate scoring 150 or more marks out of 300 shall be declared 'pass' in theory examination.
 - Candidate must score at least 150/300 in the aggregate of 3 papers to qualify the theory examination. Grace marks of up to 2% of maximum marks i.e. 6/300 shall be given only to the candidates falling in the zone of consideration i.e. securing between 144-149 marks out of 300.
 - Candidates who have qualified the theory examination are permitted to take up the practical examination.

5.2.2. Practical Examination

- Maximum Marks: 300
- Comprises of OSCE and/or Clinical Examination, and Viva.
- Candidate must obtain a minimum of 150/300 marks to qualify for the Practical Examination. There are no grace marks in Practical Examination.
- There are a maximum of two attempts that can be availed by a candidate for Practical Examination.
- First attempt is the practical examination following immediately after the declaration of theory results.
- The second attempt shall be permitted out of the next 2 sessions of DrNB Final Examination.
- Absentation from Practical Examination after successful submission of application is counted as an attempt. Appearance in first practical examination is compulsory.

-
- Requests for Change in center/ date of examination are not entertained, as the same is not permissible. Candidates are required not to canvass with NBEMS for the same.
 - DrNB Super Specialty trainees whose theses are not accepted by the National Board of Examinations in Medical Sciences by the time of announcement of practical examination centres shall not be allowed to appear in the practical examination.
 - Above scheme of practical examination may vary due to ongoing COVID 19 Pandemic.

5.3. Eligibility (Super Specialty)

5.3.1. DrNB Super Specialty Candidates:

- Candidates who have undergone training as a DrNB trainee at any of the National Board of Examinations in Medical Sciences accredited institute after having registered with NBEMS as a DrNB trainee and are completing their prescribed (as per letter of registration issued by NBEMS) training as DrNB trainee by the date mentioned below, & on submission of certificate to this effect, can undertake the DrNB Final Examination in the same specialty.

**Cutoff date for completion of DrNB Training towards
eligibility for DrNB Final Examination - June 2022**

30th November 2022

- Submission of Training Completion Certificate indicating details of leave taken during DrNB training for DrNB trainees is an essential pre-requisite. In case the candidate does not submit the training Completion certificate (as per applicable format given in Annexure III & IV) along with the application form, his/her application shall be rejected and fees forfeited.

-
- Request for extension in cutoff date for completion of training for the purpose of eligibility determination for DrNB final Examination shall not be considered.
 - **Candidates who have completed their DrNB training while applying for DrNB Final Examination** shall be required to submit Final Training Completion Certificate (FTCC) as per format prescribed in Annexure - IV.
 - **Candidates whose DrNB training is ongoing while applying for DrNB Final Examination** shall be required to submit **Provisional Training Completion Certificate (PTCC)** as per format in Annexure-III. The PTCC must confirm that the candidate would be able to complete his/her training by the prescribed cut-off, after taking into consideration all leave taken vis-a-vis the maximum permissible leave as per NBEMS leave rules and the required period of extension, if any. Such candidates are required to submit **Final Training Completion Certificate (FTCC)** as per format in Annexure-IV **immediately on completion of their training**. Such candidates shall be provisionally allowed to appear for DrNB Final Examination subject to completion of their DrNB training by the prescribed cut-off date.
 - Candidates who submit their **Provisional TCC with correct leave details** projecting their training completion on/before the prescribed cut-off date for the examination, happen to avail more leave after applying for the examination due to some unforeseen reasons which might take their training beyond the prescribed cut-off date, shall NOT be declared INELIGIBLE for the examination.
 - If such a candidate qualifies the theory and practical examination, his/her Provisional Pass Certificate shall only be issued on completion of his/her DrNB training and submission of Final TCC to this effect.

-
- If such a candidate qualifies theory examination but fails to qualify the practical examination, his/her candidature for theory examination shall remain valid and he/she shall be allowed to appear in the next remaining attempt(s) of practical examination, provided that he/she completes his/her DrNB training before the next attempt of practical examination.
 - However, candidates who at any stage are found to have misrepresented/failed to disclose the complete details of leave taken by them, in their **Provisional TCC**, shall be declared **INELIGIBLE** on failing to complete their training on/before the prescribed cut-off date for the examination. Candidature of such candidates for DrNB Final Examination shall stand cancelled and result, if any declared, shall be treated as null and void.
 - In terms of the NBEMS notice dated 26th November 2019 (published on NBEMS website <https://natboard.edu.in>), appearance in minimum required numbers of Formative Assessment Tests (FATs) during the DNB/DrNB training shall be mandatory towards eligibility for appearing in DNB/DrNB Final Examinations. This compulsory participation in FATs shall apply to candidates who have joined their training in or after July 2019 admission session.

5.3.2.DM/MCh Qualified Candidates:

- Candidates who have passed the final examination, **on or before 31st March 2022**, leading to the award of a Doctoral Degree (DM/MCh), from an Indian University, which is duly recognized as per provisions of the National Medical Commission (NMC) Act, 2019 and the first schedule of the IMC Act, 1956 can apply for the DrNB Final examination in the same Super Specialty.
- Submission of proof of having qualified final examination for DM/MCh degree on or before **31st March 2022** is an essential prerequisite. In case the candidate does not submit the requisite proof of qualifying final examination for DM/MCh

degree by the prescribed cut-off date, his/ her candidature shall be cancelled & fees forfeited.

5.4. Examination for Direct 6 Years Courses

- Candidates enrolled for DrNB Direct 6 year courses in Paediatric Surgery, Plastic Surgery, Neurosurgery and Cardiothoracic & Vascular Surgery are required to take Part – I & Part – II (Final) Examination.

After completing 2 years of DrNB training

Part I Theory Exam (Paper I & II)

Part I Practical: A

Clinical examination comprising of 4 short cases in the concerned specialty

Part I Practical: B

Clinical examination on OSCE pattern (General Surgery) and shall be common for all candidates in Paediatric Surgery, Plastic Surgery, Neurosurgery and Cardiothoracic Surgery

After qualifying Part I (Theory & Practical A + B), on being able to complete 5 years of DrNB training by the prescribed cut-off date and thesis submission to NBEMS for assessment*

DNB Final Exam (Part II) Theory

After qualifying Part II (Theory), on being able to complete 5 years of DrNB training by prescribed cut-off date and thesis acceptance by NBEMS*

DNB Final Exam (Part II) Practical

After qualifying Part II (Theory & Practical) & completing 6 years of DrNB training*

Provisional Pass Certificate/ Degree Certificate

* Subject to fulfilment of eligibility criteria

Exam	Paediatric Surgery	Paediatric Surgery	Cardiothoracic & Vascular Surgery	Neuro Surgery
Part-I	On completion of 2 years of DrNB training subject to fulfilment of Examination eligibility criteria.			
Final	On completion of 5 years of DrNB training subject to fulfilment of Examination eligibility criteria. Paper-I of the theory exam shall be exempted; Candidates are required to take only Paper-II & III of DrNB Final Theory Exam.			

5.4.1. Part I Examination for Direct 6 Years Courses

- Candidates enrolled for Direct 6-year courses (Paediatric Surgery, Plastic Surgery, Cardio Thoracic & Vascular Surgery and Neurosurgery) can take Part-I Examination on completion of their 2 years of DrNB training by the prescribed cut-off date subject to fulfilment of eligibility criteria. The cut-off date for completion of 2 years DrNB (Part I) training for the purpose of eligibility for DrNB Part I Examination June 2022 is **30th November 2022**.
- DrNB Part – I (Theory) Examination for candidates of Direct 6 year courses in Paediatric Surgery, Plastic Surgery, Neurosurgery and Cardiothoracic & Vascular Surgery comprises of two question papers.
- There are 10 short notes of 10 marks each in the question paper
- Maximum time permitted is 3 hours for each paper
- Candidate must score at least 50% of maximum marks to qualify the theory exam i.e. candidate scoring 100 or more marks out of 200 shall be declared 'pass' in theory examination.
- Candidate must score at least 100/200 in the aggregate of 2 papers to qualify the theory examination. Grace marks of up to 2% of maximum marks i.e. 4/200 shall be given only to the candidates

falling in the zone of consideration i.e. securing between 96-99 marks out of 200.

- Above scheme of practical examination may vary due to ongoing COVID 19 Pandemic
- **SYLLABUS:**

PART-I (Theory)	Paediatric Surgery	Plastic Surgery	Cardio Thoracic Surgery	Neuro Surgery
Paper – I Max Marks: 100	Basic Principles of General Surgery			
Paper – II Max Marks: 100	Basic Sciences as applied to Paediatric Surgery	Basic Sciences as applied to Plastic Surgery	Basic Sciences as applied to Cardio Thoracic Surgery	Basic Sciences as applied to Neurosurgery
Part–I Practical A & B	Yes	Yes	Yes	Yes

- Candidates who have successfully qualified the Part–I theory examination shall be required to appear in Part – I practical examination.
- Scheme for practical examination shall be sent to concerned applicant candidates.

5.4.2. Part II Examination (Final) for Direct 6 Years Courses

- Candidates who joined Direct 6 years DrNB course in Plastic surgery, Pediatric Surgery, Cardiothoracic & Vascular surgery or Neurosurgery and have **successfully qualified Part-I examination** as direct 6 years candidates can take Part–II (Final) Examination on completion of 5 years of DrNB training by the prescribed cut-off date, subject to fulfilment of eligibility criteria.
- The cut-off date for completion of 5 years DrNB training for the purpose of eligibility for DrNB Final (Part II) Examination June 2022 is **30th November 2022**.

-
- Part-II (Final) Examination is common for candidates of 3 years and direct 6 years DrNB courses in the respective super specialties. However, Direct 6 years candidates appearing in DrNB final examination shall be exempted from appearing in question Paper-I. They will be required to attempt question paper II & III only. DrNB Super specialty Candidates (3year Courses) and MCh candidates will have to attempt all the three question papers.
 - For details of Examination scheme for Part – II (Final) Examination, kindly refer to Section 5.1.

5.5. Thesis Submission to NBEMS

- As per NBEMS norms, writing a thesis is essential for all DrNB candidates towards partial fulfilment of eligibility for award of DrNB degree certificate.
- In terms of the NBEMS notice dated 06.01.2022, the last date for submission of thesis by DrNB trainees who are eligible to appear in the DrNB Final Theory Examination - June 2022 was notified as **28th February 2022**. DrNB trainees who have failed to submit their thesis to National Board of Examinations in Medical Sciences for assessment by 28th February 2022 are not eligible to apply for DrNB Final Theory Examination - June 2022.
- Candidates who have failed to qualify the Final theory examination in earlier sessions are not eligible to apply for any further final theory examinations till such time their theses are accepted by NBEMS.
- The status of thesis submission/ acceptance, as may be applicable, shall be verified the time of submission of online application for DrNB Final Theory Examination.

6. Date of Examinations & Result

6.1. DNB Final (Broad Specialty)

Paper	Day	Date	Exam Time
I	Wednesday	22-06-2022	2:00 PM-5:00 PM
II	Thursday	23-06-2022	2:00 PM-5:00 PM
III	Friday	24-06-2022	2:00 PM-5:00 PM
IV	Saturday	25-06-2022	2:00 PM-5:00 PM

6.2. DrNB Final (Super Specialty)

Paper	Day	Date	Exam Time
I	Wednesday	22-06-2022	2:00 PM-5:00 PM
II	Thursday	23-06-2022	2:00 PM-5:00 PM
III	Friday	24-06-2022	2:00 PM-5:00 PM

6.3. DrNB Super Specialty Direct 6 Years Course - Part - I

Paper	Day	Date	Exam Time
I	Wednesday	22-06-2022	2:00 PM-5:00 PM
II	Thursday	23-06-2022	2:00 PM-5:00 PM

6.4. DNB/DrNB Final Practical Examinations:

- The date, time and venue of practical examination shall be intimated to all candidates who have qualified theory examinations through their Online Exit Examination Portal (OEEP) account.
- NBEMS reserves its rights to allot a practical center anywhere in the country; the candidates shall make their own arrangement for travel/boarding etc. Change in centre of the practical examination is not permitted under any circumstances. Candidates are advised not to make any representations/ not to canvass in this regard.

6.5. Admit Card:

- The admit card of the candidate for theory examination shall be available for download at NBEMS website <https://natboard.edu.in> from **16th June 2022**. Candidates are required to take print out of their admit card from the website, paste their photograph at the designated place and appear at exam centre along with one of the following original and valid/non-expired ID proof:
 - ❖ PAN Card
 - ❖ Driving License
 - ❖ Voter ID
 - ❖ Passport
 - ❖ Aadhaar Card (with Photograph)

6.6. Declaration of DNB/DrNB Final Examination Result:

- DNB/DrNB final is a qualifying examination.
- Results of DNB/DrNB final examinations (theory & practical) are declared as PASS/FAIL. In case, the applicant candidate is provisionally eligible on date of declaration of result his/her result shall be withheld & shall be declared only upon status being eligible, on receipt of required documents by the prescribed cut-off date.
- The details of marks obtained/grading in final theory/practical Examinations will be provided to all the candidates. Procedure for obtaining question wise marks can be seen at NBEMS website (Notice dt. 20.04.10, 14.12.11).
- There will be **no re-evaluation or rechecking/ re-totaling of answer sheets**. Requests for re-evaluation/re-totaling shall not be entertained.
- Results can be seen on NBEMS website <https://natboard.edu.in>

-
- No separate certificate for passing theory examination will be issued.
 - Candidates successful in the practical examination are issued Provisional Certificate of Passing DNB/DrNB. Provisional Pass Certificates are valid till issuance of DNB/DrNB degree certificate in convocation of National Board of Examinations in Medical Sciences for all purposes, including but not limited to, employment, registration with state medical councils etc.
 - Under normal circumstances the certificates of passing are issued to the candidates within four weeks of declaration of results, however, due to unforeseen circumstances, this period may vary.
 - For issuing a duplicate provisional pass certificate, submit a request letter stating reasons to issue a duplicate certificate, copy of FIR lodged with police authorities clearly mentioning the loss/non-receipt of certificate, affidavit in support of application (attested by public notary/oath commissioner/judicial magistrate), fee of Rs. 1000/- + GST@18% for document upto preceding 3 years and Rs. 2000/- + GST@18% for documents more than three years old. The demand draft should be made in favour of National Board of Examinations in Medical Sciences, payable at New Delhi.
 - Candidates are advised not to canvass or approach NBEMS for handing over the passing certificate by hand. Certificates are dispatched to the correspondence address provided in the application form.

6.7. Award of DNB/DrNB Degree certificates

- Candidates who have qualified both DNB/DrNB Final Theory & Practical Examinations, and whose theses have been accepted by National Board of Examinations in Medical Sciences, shall be conferred with DNB/DrNB degree in the specialty concerned on enrolment for the convocation.

-
- National Board of Examinations in Medical Sciences shall be conferring DNB/DrNB degree subject to fulfilment of eligibility criteria at the Convocation Ceremony. Details for the same are announced separately at NBEMS website <https://natboard.edu.in>

7. Centres for Final Examinations

7.1. The tentative list of cities where DNB/DrNB Final Theory Examination shall be conducted is as follows:

S. No	City	S. No	City
1	Ahmedabad	27	Pune
2	Amritsar	28	Raipur
3	Belgaum	29	Ranchi
4	Bengaluru	30	Thiruvananthapuram
5	Bhopal	31	Vijaywada
6	Bhubaneswar	32	Visakhapatnam
7	Chandigarh/Mohali		
8	Chennai		
9	Coimbatore		
10	Delhi NCR		
11	Guwahati		
12	Hyderabad		
13	Imphal		
14	Indore		
15	Jaipur		
16	Jammu		
17	Kochi (Ernakulam)		
18	Kolkata		
19	Kozhikode		
20	Lucknow		
21	Madurai		
22	Mangaluru		
23	Mumbai		
24	Nagpur		
25	Patna		
26	Puducherry		

-
- 7.2. At the time of online submission of application form, the candidate will be required to indicate his/her FIRST and SECOND choice of the exam city in which he/she wants to take the exam. NBEMS will make all efforts to allocate the exam centre in the city of FIRST choice.
- 7.3. **Requests for change of testing centre / city shall not be entertained.** Candidates are advised not to canvass for the same.
- 7.4. The exact venue/centre address will be informed to the candidates through admit card which will be uploaded on NBEMS website <https://natboard.edu.in> The admit card of the candidate shall be available for download by **16th June 2022**. The Candidates shall make their own arrangement for travel/boarding etc.
- 7.5. Candidates are required to take print out of their admit card from the website, paste their photograph at the designated place and appear at exam centre along with one of the following original and valid / non-expired ID proof:
- ❖ PAN Card
 - ❖ Driving License
 - ❖ Voter ID
 - ❖ Passport
 - ❖ Aadhaar Card (with Photograph)

8. Instructions to Fill Online DNB/ DrNB Final Application Form

- 8.1. Applicant candidates shall be required to register online at *Online Exit Examinations Portal (OEEP)* for submission of DNB/DrNB Final Examination application to National Board of Examinations in Medical Sciences. The Online Exit Examination Portal can be accessed through NBEMS website <https://natboard.edu.in>
- 8.2. After successful registration and submission of application, candidates can login to their *OEEP* account to check the status of the online application submitted for DNB/DrNB Final Examinations, any deficiency communicated to them to download the admit cards
- 8.3. Application for DNB/DrNB Final Theory Exam - June 2022 can only be submitted online through National Board of Examinations in Medical Sciences website <https://natboard.edu.in> There is no other methodology for application submission. Application submitted through any other mode shall be summarily rejected.
- 8.4. Following steps shall be required to be completed in sequence for application submission to NBEMS:
 - A. Register a User - *Online*
 - B. Complete Application form, Examination City Selection and Upload Prescribed Documents - *Online*
 - C. Pay Examination Fee - *Online*
- 8.5. The applicant candidate shall register a username and create his/her online profile with *Online Exit Examinations Portal*. On successful creation of candidate profile, the applicant shall be required to complete the DNB/DrNB Final Examinations application form, pay the prescribed examination fee and upload the prescribed documents online. Candidates shall be able to preview the

application form for any corrections required before final submission.

- 8.6. The applicant candidate may save and print the application form submitted online for future reference. There is no requirement to submit the hard copy print out of the application form and documents uploaded to NBEMS.
- 8.7. The *Online Exit Examinations Portal* shall be the window of communication with the applicant candidate. DNB/DrNB Final Examinations related information shall be accessible to the candidate at this portal.

A. Register a User - *Online*

- 8.8. New User Registration: All candidates desirous of applying for DNB/DrNB Final Examinations shall be required to create a profile with *Online Exit Examinations Portal (OEEP)*. The applicant candidate can always modify some of the information in the existing profile by logging in using its user ID and password. If password is lost, it can be retrieved by clicking "*Forgot Your Password*".
- 8.9. After opening the NBEMS website <https://natboard.edu.in>, click on Exit Exam Portal Quick link (available in top bar) to access the *Online Exit Examinations Portal (OEEP)*. To apply for DNB Final Examination June 2022, Click at "*Apply for DNB/DrNB Final Examination*". You will be diverted to a Registration/login page.
- 8.10. If the applicant candidate is a first time user at this portal, click "*Register New User?*"
- 8.11. **Candidates who have already registered a user in Dec 2019 or June 2020 or Dec 2020 or June 2021 or Dec 2021 session at OEEP portal are strongly advised not to re-register a new user. The User ID created by them in earlier sessions shall NOT be operational now. A**

new user ID & Password shall be shared with all such candidates at their registered email ID once the application form goes live. Please check your registered email ID for the User ID and Password shared.

- **Username/User ID:** Candidates who would register a "New User" will get their system generated username/User ID and password at the email ID provided on completion of profile creation. Application ID is generated after successful submission of an application. Application ID is not the User ID for login purpose.
- **Name:** Please mention the **full name as in the Letter of Registration issued by NBEMS or Name mentioned in MD/MS or DM/MCh degree certificate, as the case may be.** Changed name shall not be considered. *Name once registered with the profile can not be edited in the applications to be submitted.* Requests for change in name after conduct of examination/declaration of result shall not be considered.
- **Gender, Date of Birth and Nationality:** Indicate your gender; Day, Month & Year of your birth and Nationality.
- **Email ID:** Email ID chosen by the applicant candidate shall be verified through a system generated OTP for user creation. Same email ID can not be used for registration of any other user concurrently. Please note that all email correspondence with the applicant candidate shall be done at this email ID only. *Correspondence received from any other email ID of the candidate shall not be entertained.*
- **Mobile No:** Please provide the desired mobile number for receiving all Exit Examinations related communications. Please note that all telephonic correspondence with the applicant candidate shall be done at this mobile number only. You can always modify the existing profile by logging in using your user ID and password.

B. Complete Application form, Examination City Selection and Upload prescribed documents - *Online*

- After registering the user, please choose the correct tab for the examination you wish to appear in. The candidate can either continue to fill the desired application form by clicking at the link "**Go to Application Form**" or can fill the application at a later stage after login in using the User ID and Password received at email.

8.12. The homepage of the *Online Exit Examinations Portal* provides two quick links:

8.12.1. *Apply for DNB/DrNB Final Examinations*: The online application form for DNB/DrNB Final Examinations can only be accessed through this quick link. To create a user and to submit the application for June 2022 session, click on this link. After registration of user and getting a User ID, again click on this link and login to complete & submit the application form.

8.12.2. *Candidate Login after Application Submission*: This login would allow tracking the status of application, deficiency issued if any, to download Admit Card and access to practical examination details once the candidate qualifies the theory examination. This login shall be active only for those who have successfully submitted an online application. It may take few days after application submission for this login to be active.

8.13. While filling the application form, the candidate shall be required to select one of choices under following heads :

- **Select Your Examination:**

Theory & Practical/Only Practical

DNB Final Broad Specialty/DrNB Final Super Specialty/Direct 6 Years Course DrNB Part I /Direct 6 Years Course DrNB Part - II

-
- **Select Specialty for Examination to be taken**
 - **Category of Candidate:**
 - **Broad Specialty:** *Post MBBS DNB Candidate/ Post Diploma DNB Candidate/ MD-MS Qualified Candidate*
 - **Super Specialty:** *DrNB Superspecialty Candidate/ DM-MCh Qualified Candidate*

8.14. The candidates who have been DNB/DrNB trainees shall be required to enter their Registration Number provided by National Board of Examinations in Medical Sciences in the letter of registration issued to them. Please enter the registration number in the same format as mentioned in the letter of registration. The system will check the status of thesis submission and acceptance thereafter. After entering the registration number, click on the link “Click here to see thesis status” to fetch your thesis status. Candidates who fulfill the thesis related requirement prescribed in the bulletin shall alone be allowed to complete the application form. For any query related to thesis status/status not being updated in NBEMS database, please contact thesis section of NBEMS through the communication web portal of NBEMS.

8.15. **Upload of Prescribed Documents, Photograph and Scanned Signatures:** The candidate shall be required to upload **scanned copies of original documents** at indicated places as per details mentioned below:

Applicable Only For DNB/DrNB Candidates:

- MBBS Degree Certificate
- DNB/DrNB Training completion certificate as per the format given in the information bulletin at Annexure-III/IV.
- Registration letter issued by NBEMS.
- Thesis acceptance letter issued by National Board of Examinations in Medical Sciences/Proof of submission of thesis to National Board of

Examinations in Medical Sciences for assessment, which ever is applicable as per information bulletin

- National Board of Examinations in Medical Sciences approval in cases of extension of training (in cases of Maternity leave/ Paternity Leave/ Medical Leave/ Excess leave)

Applicable Only For MD/MS/DM/M.Ch Candidates:

- MBBS Degree Certificate
- MD/MS/DM/M.Ch Degree certificate/Provisional Pass Certificate (PPC)**##
- Following documents supporting post graduate qualification being recognized as per the provisions of the NMC Act 2019/ the First Schedule of the IMCAct 1956:
 - **Self attested copy of print-out of NMC website (www.nmc.org.in)** confirming to the additional PG Degree qualification being "Recognized" as per provisions of the NMC Act and the first schedule of IMC Act.
 - If additional PG degree qualification is **NOT listed as "Recognized"** on NMC website, please upload one of the following two documents:
 - Additional Qualification Registration Certificate (AQRC) issued by NMC/MCI, OR
 - Additional Qualification Registration Certificate (AQRC) issued by State Medical Council + IMR Certificate issued by NMC/MCI wherein said additional PG Degree qualification is listed as registered

**##

- ❖ *If PPC/Degree Certificate of MD/MS or DM/MCh qualification has not been issued, a copy of result notification duly certified by the Dean/Registrar/ Principal of the university/medical college as a proof of declaration of MD/MS or DM/MCh result in public domain on or before 31st March 2022 to be submitted. Such candidates shall be required to submit the Provisional Pass Certificate/Degree Certificate of MD/MS or DM/MCh qualification before declaration of DNB/DrNB final theory results.*

For All Candidates

Please upload following as per Image Upload Guidelines mentioned at the end of this Information Bulletin:

- **Latest Photograph**

-
- **Scanned Signatures**
 - **Thumb Impression**

Admit Cards will not be issued to the candidates who fail to submit the above mentioned essential documents.

C. Pay Examination Fee

- 8.16. **Payment of Fee:** The candidate shall be required to make requisite payment of prescribed examination fee online.
- 8.17. After successful payment of required fee, the process of submission of the application of the candidate shall be completed.
- 8.18. **Acknowledgement of Online Application Submission:** An acknowledgement email shall be sent for receipt of online DNB/DrNB Final Examinations Application at NBEMS. The acknowledgement shall bear an **Application Form ID**. Please preserve this form ID for future correspondence with National Board of Examinations in Medical Sciences regarding application.

D. Quick Links on Online Portal:

- 8.19. After successful submission of online application for DNB/DrNB Final Examination, the candidate access Exit Examination Portal at National Board of Examinations in Medical Sciences website <https://natboard.edu.in> and needs to login through the quick link "**Candidate login after application submission**". This login shall be active few days after the application submission.
- 8.20. **Status of Application:** The applications submitted by the candidates can be tracked through *Online Exit Examinations Portal* (OEEP) for status of application processing. Updated processing status of application submitted shall be reflected on the portal.

-
- 8.21. Candidates who are issued admit card by NBEMS shall be able to download the admit card/other communications through *Online Exit Examinations Portal*.
- 8.22. The candidate shall also be able to upload deficient documents, if so required by National Board of Examinations in Medical Sciences, through this portal.
- 8.23. **Update Profile:** The candidate shall be able to update the mobile number, email ID, correspondence address by clicking "*Update Profile*" quick link. No other parameter shall be updated in NBEMS records unless supported with appropriate authenticated documents.
- 8.24. **Change Password:** The candidate shall be able to update his/her Password through *Online Exit Examinations Portal*.
- 8.25. **Information Bulletin:** The candidate can access Information Bulletins through this quick link.
- 8.26. **Notices & Circulars:** Relevant notices and circulars shall be uploaded here.

9. Unfair Means

If during the course of training / examination, a candidate is found indulging in any of the following, he/she shall be deemed to have used unfair means.

- 9.1. Candidate undergoing DNB/DrNB training if by himself or in connivance with the accredited Institute authorities tries to abstain himself from DNB/DrNB training or submits false/ forged certificate towards DNB/DrNB training.
- 9.2. Maintaining incomplete/incorrect log book, attendance records, training schedule, thesis work etc.
- 9.3. Submission of DNB/DrNB training certificate with wrong dates of joining and completion of training.
- 9.4. Candidate misbehaving or using abusive language with other DNB/DrNB trainees or patients or staff of accredited institute or with the faculty of the accredited institute.
- 9.5. Candidate who has resigned from DNB/DrNB course (after joining the DNB/DrNB course) if appears for DNB/DrNB entrance during the scheduled duration of training.
- 9.6. If a candidate is found to have made a wrong statement in his/her online application form for admission to the examinations / counseling / training or has attempted to secure or has secured admission to any of the examinations of NBEMS by making a false statement or by production of a false document.
- 9.7. If at any stage a candidate has tampered with any entry in the certificate or statement of marks or any certificate issued by any governmental or non-governmental body or any other document that has been issued to him/ her NBEMS.

-
- 9.8. In the answer book, a candidate is not permitted to write his/her name or put his/her signature (except on the jacket of the answer sheet) or put any sign or mark which may disclose his/her identity to the examiner.
 - 9.9. Use/possession of any kind of electronic gadgets including mobile phones with or without internet (whether the gadgets are actually used or not).
 - 9.10. Having in possession of any note-book(s) or notes or chits or any other unauthorized material concerning the subject pertaining to the examination paper.
 - 9.11. Anything written on any part of clothing, body, desk, table or any instrument such as set square, protractor, blotting paper and question paper etc.
 - 9.12. Giving or receiving assistance directly or indirectly of any kind or attempting to do so.
 - 9.13. Change of seat without the permission of Examination Superintendent/ In charge Computer Laboratory.
 - 9.14. Writing questions or answers on any material other than the answer.
 - 9.15. Tearing of any page of the answer book or supplementary answer book etc.
 - 9.16. Contacting or communicating or trying to do so with any person, other than the Examination Staff, during the examination time in the Examination center/Computer Laboratory.

-
- 9.17. Consulting notes, books or any other material or outside person while going out of the examination hall/ Computer Laboratory to toilet or to any other place.
- 9.18. Impersonation.
- 9.19. Candidate appearing multiple times with same or different identity in different sessions of same examination conducted on Computer Based Testing platform.
- 9.20. Using or attempting to use any other undesirable method or means in connection with the examination.
- 9.21. Taking away the answer book out of the examination hall/room. Smuggling out Question Paper or its part; or smuggling out answer book/ supplementary answer sheet or part thereof.
- 9.22. Running away or swallowing or destroying any note or paper or material found with him/her
- 9.23. If the answer books show that a candidate has received or given help to any other candidate through copying.
- 9.24. Threatening any of the officials connected with the conduct of the examinations or threatening of any of the candidates.
- 9.25. Found exchanging answer book or question paper with solution or copying from unauthorized material.
- 9.26. Peeping into the computer monitor screen of the other candidate.
- 9.27. Disclosing his/her identity or making distinctive mark in the answer book for that purpose or fails to deliver his/her answer book/ continuation sheet before leaving the examination hall.

-
- 9.28. Hacking or attempting to hack or causing interference with the website of NBEMS or its Technology Partner(s) or their Information Technology systems.
- 9.29. Tampering with Information Technology systems of NBEMS or Technology Partner(s) or Computer Laboratory.
- 9.30. Damaging the computer systems of computer Laboratory.
- 9.31. Candidate found to have attempted or trying to attempt personally or through another person to influence or pressurise an examiner, or any officer or official connected with the examinations of the NBEMS or its technology partner, either at the Board or at the office of technology partner or their respective residence(s), in any matter concerned with the examinations.
- 9.32. If at any stage if it is found that the candidate has appeared multiple times in the same session of examination or has appeared in same or different examination of NBEMS with different names, unfair means case shall be registered against such candidate and dealt accordingly.
- 9.33. Any act of candidate/any person which is detrimental to safe, secure and smooth conduct of examination and the decision of EEC in this regard shall be final.
- 9.34. Candidate is found talking/peeping to another candidate during the examination hours in the examination room.
- 9.35. A candidate who refuses to obey the Superintendent of Examination center/ Computer Lab and changes his/her seat with another candidate and/or creates disturbance of any kind during the examination and/or otherwise misbehaves in the examination hall.

-
- 9.36. A candidate found copying from notes written on any part of his/her clothing, body, desk or table or instrument like set squares, protractors, scales etc. or who is found guilty of concealing, disfiguring, rendering illegible, swallowing or destroying any notes or papers or material found with him/her or found exchanging answer book or question paper with solution or talking to a person or consulting notes or books outside the Examination Hall, while going to the toilet or in the toilet.
- 9.37. Any candidate found guilty of having adopted anyone or more of the above Unfair means/misconduct is liable to be penalized with a penalty by the Ethics Committee, which may vary from cancellation of the examination/ expulsion up to next 14 attempts or 7 yrs and/or cancellation of candidature as may be decided by Examinations Ethics Committee after considering each case.
- 9.38. The above list is purely indicative. If any act of omission or commission attributed to the candidate/intent by the candidate to vitiate the sanctity of the examination in decision of NBEMS shall be taken up as unfair means.

10. Communication Protocols

10.1. Information in this information bulletin and National Board of Examinations in Medical Sciences website <https://natboard.edu.in> will guide you through the entire process and help answer most of your queries.

10.2. Application status related updates shall be available time to time on *Online Exit Examinations Portal (OEEP)*.

10.3. In case you are still facing issues, then you can contact NBEMS through any of the following modes:

- **NBEMS Candidate Care helpline (For Queries related to Application Form Submission ONLY):**

Helpline Number	022 - 61087595
Email	exitexamhelpdesk@natboard.edu.in
Official Website	https://natboard.edu.in

- **Communication Web Portal:**

<https://exam.natboard.edu.in/communication.php?page=main>

- **By Post:**

Executive Director
National Board of Examinations in Medical Sciences,
Medical Enclave,
Ansari Nagar,
New Delhi -110029

10.4. Queries shall only be processed if same are sent through email ID of candidate registered with NBEMS.

10.5. Following Information must be provided in queries addressed to National Board of Examinations in Medical Sciences regarding DNB Final Examinations:

- *Name of Applicant Candidate*
- *Email ID*
- *Mobile Number*
- *Correspondence Address*
- *Application Form ID/Roll Number for DNB/DrNB Final Examination*
- *Specialty of Examination*

*** Queries sent without aforesaid information may not be entertained.**

10.6. Do not send the same query multiple times, as it will delay the response process.

10.7. Queries shall not be entertained from persons claiming themselves to be representative, associates or officiates of the applicant candidate.

11. Leave Rules for DNB/DrNB/FNB Trainees

The following revised leave rules shall apply to the candidates, who have joined in or after 2018. Those who joined before 2018, the old leave rule shall be applicable.

11.1. DNB/DrNB/FNB Trainees are entitled to avail leave during the course of DNB/DrNB/FNB training as per the Leave Rules prescribed by NBEMS.

11.2. A DNB/DrNB/FNB Trainees can avail a maximum of 30 days of leave in a year excluding regular duty off/ Gazetted holidays as per hospital/institute calendar/policy. This leave shall be processed at the institutional level.

11.3. Any kind of study leave is not permissible to DNB/DrNB/FNB Trainees.

11.4. Under normal circumstances leave of one year should not be carried forward to the next year. However, in exceptional cases such as prolonged illness, the leave across the DNB/DrNB/FNB training program may be clubbed together with prior approval of NBEMS.

11.5. Unauthorized absence from DNB/DrNB/FNB training for more than 7 days may lead to cancellation of registration and discontinuation of the DNB/DrNB/FNB training and rejoining shall not be permitted.

11.6. Any Leave availed by the candidate other than the eligible leave (30 days per year) shall lead to extension of DNB /DrNB/FNB training. The training institute has to forward such requests to NBEMS along with the leave records of the candidate since his/her joining and

supporting documents (if any) through the Head of the Institute with their recommendation/comments. NBEMS shall consider such requests on merit provided the seat is not carried over and compromise with training of existing trainees in the Department.

- 11.7. Any extension of DNB/DrNB/FNB training beyond the scheduled completion date of training is permissible only under extra-ordinary circumstances with prior approval of NBEMS. Such extension is neither automatic nor shall be granted as a matter of routine.
- 11.8. DNB/FNB trainees are required to complete their training by a prescribed cutoff date (as per information bulletin of Exit exam) for being eligible to DNB/ DrNB/FNB Exit examination.
- 11.9. The eligibility for DNB/DrNB/FNB Final Examination shall be determined strictly in accordance with the criteria prescribed in the respective information bulletin.

Image Upload Instructions

Before applying online, a candidate will be required to have a scanned (digital) image of his/her photograph, signature and thumb impression as per the specifications given below. Your online application will not be registered unless you upload your photograph, signature and thumb impression as specified.

A. PHOTOGRAPH

Processes for photo upload:

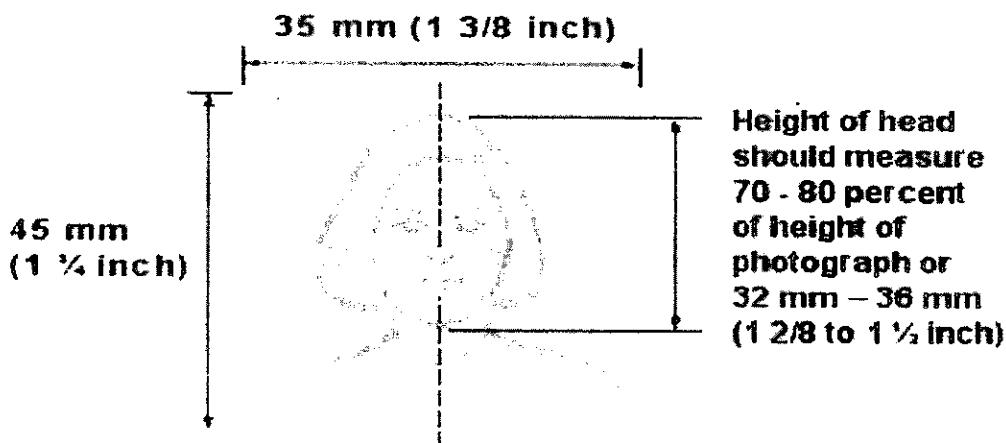

The candidate shall be required to upload **TWO** photographs:

1. A **REAL TIME PHOTOGRAPH** taken by the webcam/in-built camera of the computer system while filling the online application form:
 - a. Stand/sit against a **white background** in bright light (Avoid distracting backgrounds)
 - b. The image must not include other objects or additional people. Ensure that you are only one person in picture.
 - c. The image must contain the full face, ears, neck, and shoulders of the entrant in frontal view with a neutral, non-smiling expression and with eyes open and directed at the camera.
 - d. The image must not contain any parts of the body below the entrant's shoulders.
 - e. Click on "Capture Photo" button in the application form.

2. Upload a **PRE-SAVED RECENT PHOTOGRAPH** which can be prepared in one of the two ways:

- Clicking a photograph through a digital camera
- By scanning the physical photograph.

I. CLICKING YOUR PHOTO

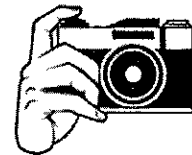

- Stand/sit against a **white background** (Avoid distracting backgrounds)
- The image must not include other objects or additional people. Ensure that you are only one person in picture.
- The image must contain the full face, ears, neck, and shoulders of the entrant in frontal view with a neutral, non-smiling expression and with eyes open and directed at the camera.
- The image must not contain any parts of the body below the entrant's shoulders.
- Click colour photograph in **bright light** using any digital device preferably with > 5-megapixel resolution). Avoid using flash as it tends to create a shadow on the white background.
- Avoid selfie; ask someone else to take the picture for you. They might also help to direct you a bit, like telling you to straight your head or tuck your hair behind your ears.

Editing of digital photograph:

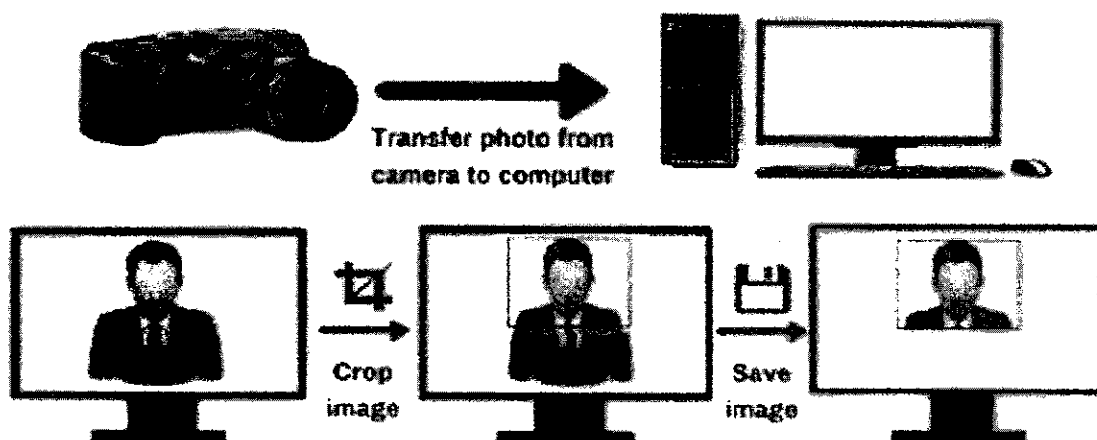

-
- a. the photograph from the digital device to a computer/laptop.
 - b. the photograph such that your head, shoulders are visible and occupy most of the image.
 - c. The size of image should be less than 80kb. Size of the image can be checked by right click on the image and then go to "Properties" link. (maintain aspect ratio, i.e. height and width ratio to avoid distortion of image)

II. PHOTO SCAN PROCESS

In case you already have a professionally clicked passport size colour photograph follow the following procedure to prepare scanned image of the same.

Before you scan the photograph ensure that

- a. Photo has been taken against a white background without a border and clearly shows your face, eyes and both ears.
- b. The photograph is of standard passport size (35mm X 45mm, width X height)
- c. The photograph is recent (within 6 months of online application).
- d. Choose a solo photo for scanning. Cropping a group photo isn't acceptable.
- e. Profile photograph is not acceptable.

Scanning process of already available photograph

- a. **Draw a box** minimum 35x45 mm size on a white sheet of paper using pencil.
- b. Affix your latest passport size photograph in the draw box.
- c. Set the scanner resolution to a minimum of 200 dpi (dots per inch)
- d. Set Color to True Color
- e. **Place sheet of paper face down on the printer or scanner surface. Press scan button on the scanner or use the scanning program on your computer.**
- f. **Crop** the image such that borders of box are reached.

- g. Save the scanned images as .jpg/.jpeg as "Photograph.jpg" or "Photograph.jpeg".
- h. The size of image should be less than 80kb. Size of the image can be checked by right click on the image and then go to "Properties" link.
- i. If the size of the image is more than 80 kb, then adjust the settings of scanner such as set the dpi of the scanner to 200 dpi and quality of image at low. If image size is still more than 80 kb then resize the image to the given specifications.

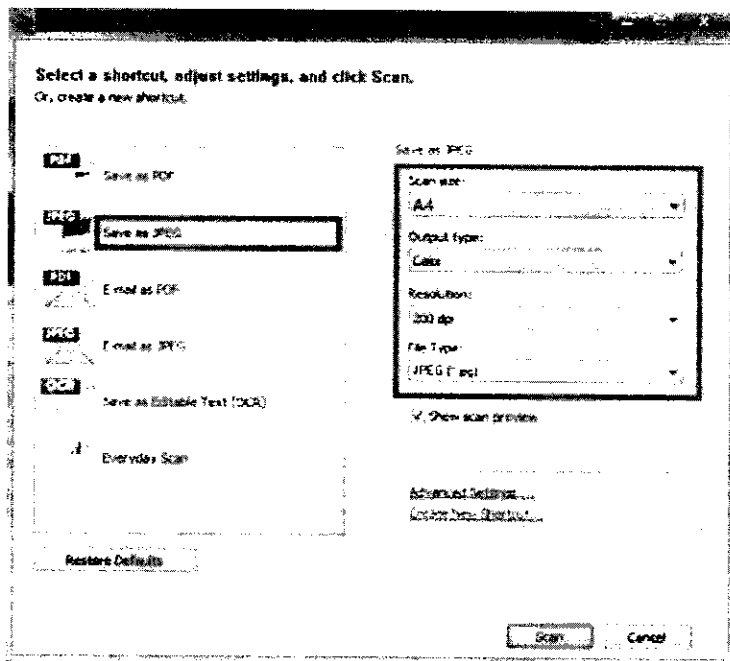
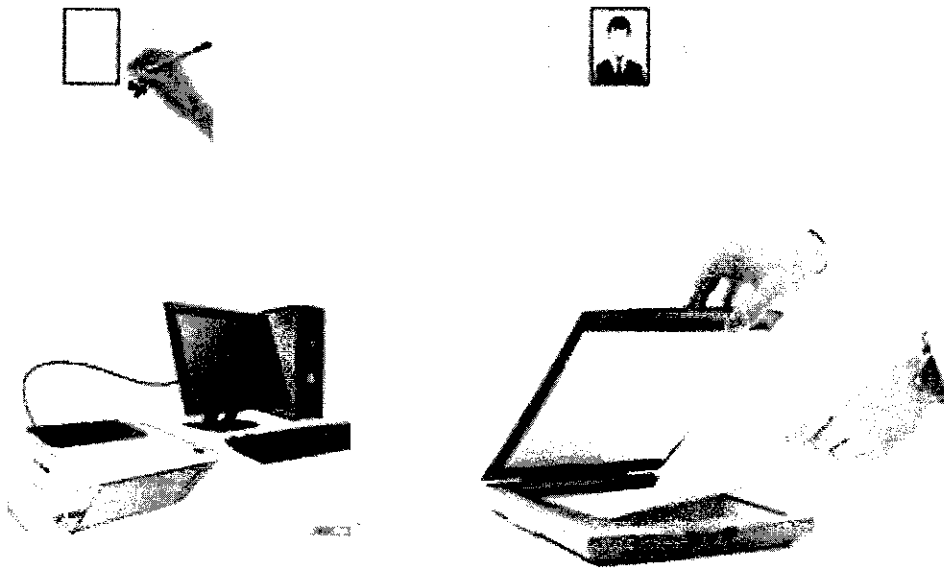

Checklist before uploading digital image of photo



- a. Photograph is in colour with white background.
- b. Your face is clearly visible.
- c. The size of image should be less than 80kb.
- d. Image is in .jpg/ .jpeg format.
- e. Image is not blurred in the process of editing.
- f. Digital enhancement or other alterations or retouching are not permitted.
- g. Make sure your face takes up at least 70-80% of the frame.

B. SIGNATURE

Digital image of your Signature can be made in two ways:

- Using a digital device to directly image (i.e. camera)
- Scanning the signature

I. PREPARING DIGITAL IMAGE OF SIGNATURE USING A DIGITAL DEVICE (CAMERA)

Clicking image of signature using a digital device:

- a. Draw a box of size 1.5 cm (height) × 3.5 cm (width). Use a black or dark blue ink pen to sign within this box.
- b. Click the signature within the box in bright light conditions using any digital device (preferably with > 5-megapixel resolution). Avoid using flash.

-
- c. Check the shadow of your hands/camera/smartphone etc. does not fall on the sheet.

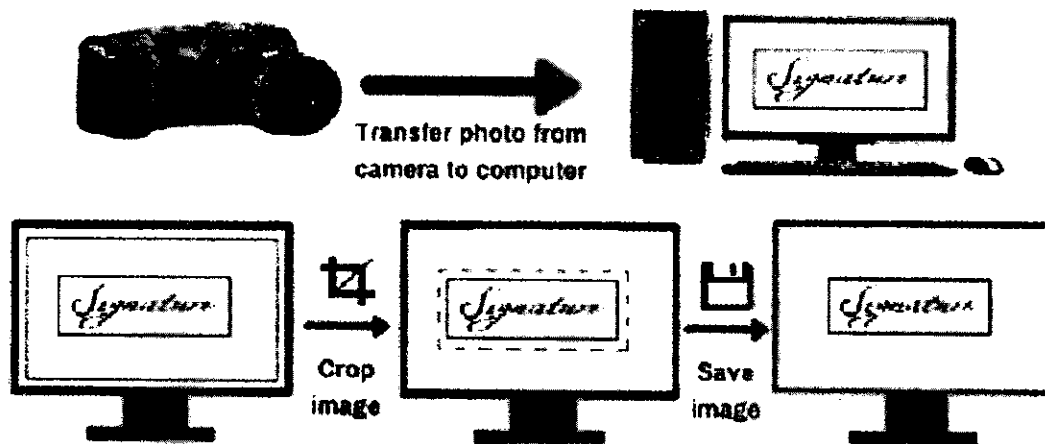

Editing digital image of the signature:

- Transfer the digital image to a computer/laptop.
- If required, use **auto-correct** feature of image editing software so that the signature is clear against a white background.
- Crop** the image such that borders of box are reached.
- Resize** the image to 20 – 100 Kb (maintain aspect ratio, i.e. height and width ratio to avoid distortion of image)

II. SCANNING THE SIGNATURE:

- The signatures should be **done by the candidates only** as it may be checked any time frequently.
- Signature done on the blank white page without lines only will be accepted
- Take the white sheet and mark the box size of 3.5 x 1.5 cm (width x height)
- Sign inside the box with **blue/black pen**.
- If the Candidate's signature on the answer script, at the time of the examination, does not match the signature on the Attendance Sheet, the candidate will be disqualified.
- Set the scanner to 200 dpi
- The scanned image should be saved in .jpeg/.jpg format.
- Crop only box area.

-
- i. The size of image should be less than 80kb.

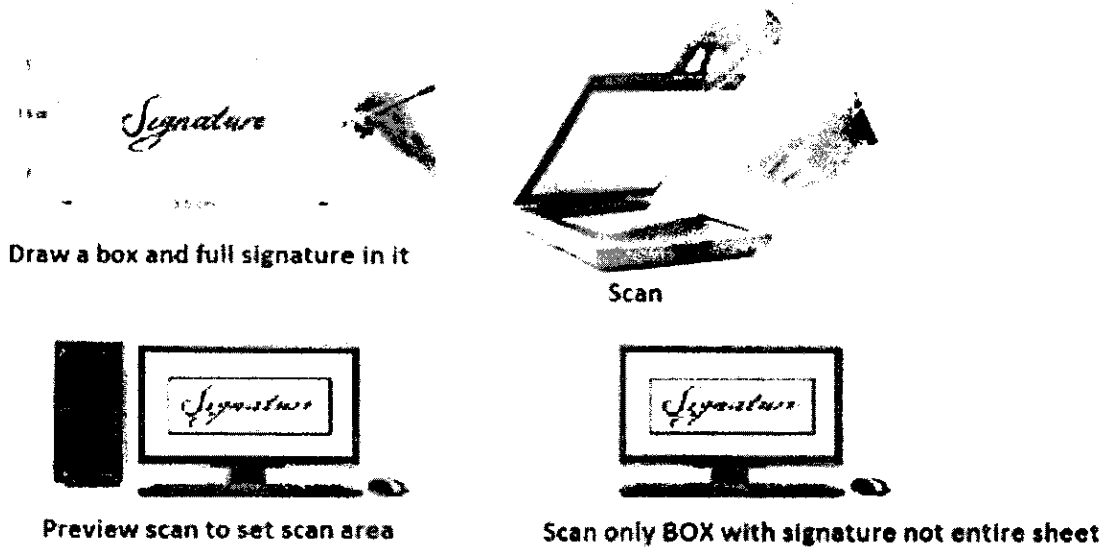

C. THUMB IMPRESSION

Instruction for preparing digital image of thumb print

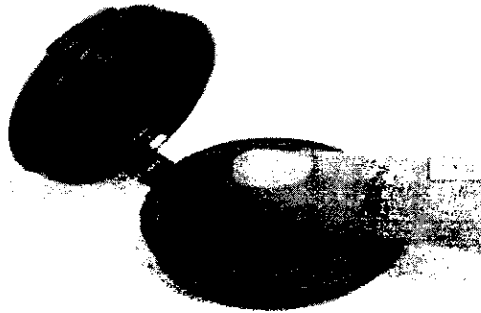

Taking a thumb-print

- Draw a box of 3.5 cm x 1.5 cm (width x height) on a white sheet of paper (you may draw more than 1 box to take multiple thumb print and select the best).
- Use a fresh **blue/black colour ink pad**.

- c. Practice on a sheet of paper to get the proper thumb-print especially the density or darkness of the colour. The impression of the print should be clear and readable; neither dark nor smudged or light.
- d. Clean your hands and dry them before you begin (oil/dirt can obscure the prints)
- e. Gently press your **LEFT THUMB** against the ink pad and take a horizontal print of your left thumb within the box. Do not press too much or wriggle as it may lead to smudging of print. Preferably take impressions of thumb in more than box.

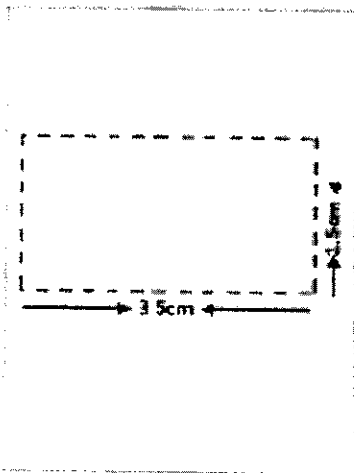

Draw a box of 1.5cm x 3.5cm for Left thumb impression

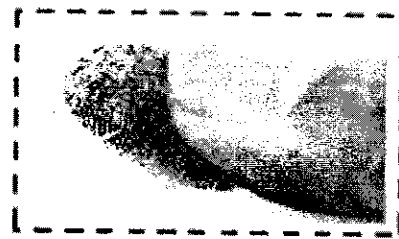

Left thumb impression within the box

I.PREPARING DIGITAL IMAGE OF THUMB IMPRESSION USING A DIGITAL DEVICE (CAMERA)

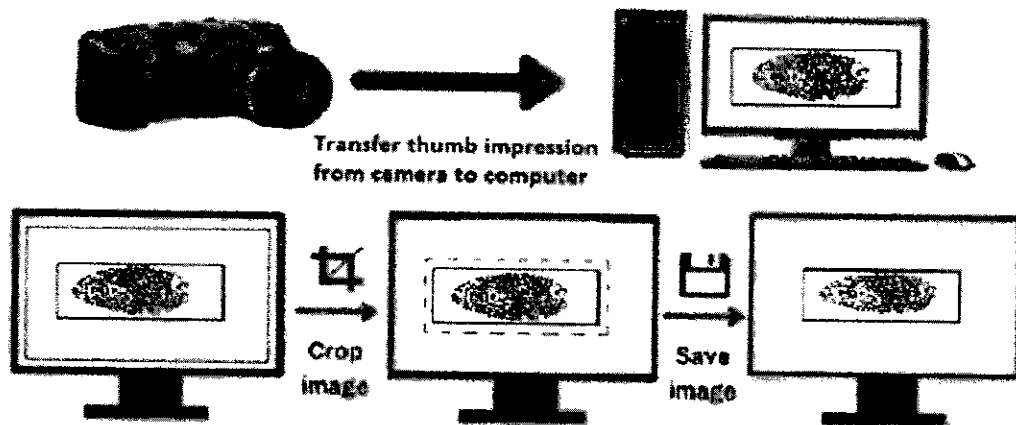

II. SCANNING THE THUMB IMPRESSION



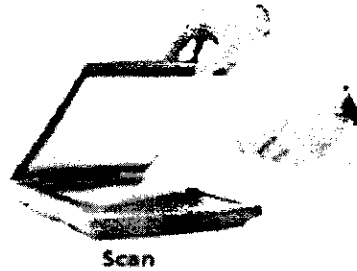
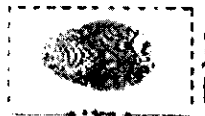



- a. Set the scanner to 200 dpi.
- b. Save the scanned image of thumb-print as .jpg/ .jpeg format.
- c. Crop only box area.
- d. The size of image should be less than 80kb. Size of the image can be checked by right click on the image and then go to "Properties" link.





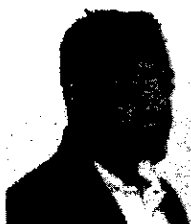















Preview scan to set scan area





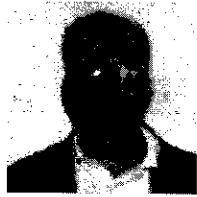



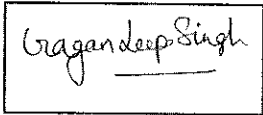



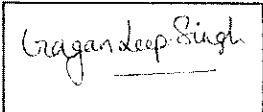

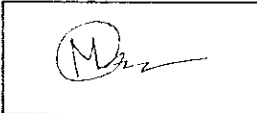
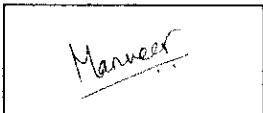

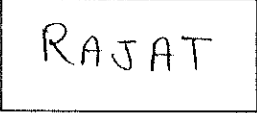
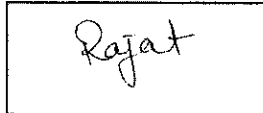







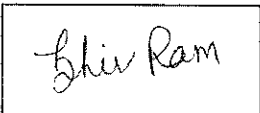

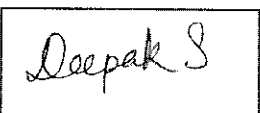

Scan only BOX with signature not entire sheet



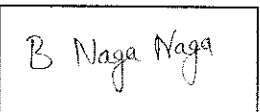

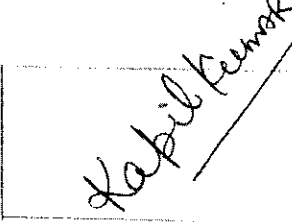
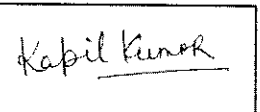

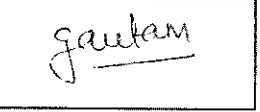
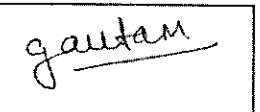
INSTRUCTIONS FOR ACCEPTABLE PHOTOGRAPHS		
Not Acceptable	Reason for Rejection	Acceptable
	Cropped image	
✘		✔
	Not looking straight into camera	
✘		✔
	Black & White Photographs	
✘		✔

	<p>Improper flash or improper lighting</p>	
		
	<p>Photo taken with mobile phone (including "selfies") resulting in distorted face</p>	
		
	<p>Distortion due to enlargement of an original smaller image</p>	
		
	<p>Improper Background or Sunglasses</p>	





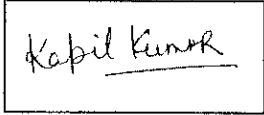

×		✓	
	Too much glare on spectacles		
×		✓	
	Spectacle rim over eyes		
×		✓	
INSTRUCTIONS FOR ACCEPTABLE SIGNATURES			
Not Acceptable Signature	Reason for Rejection	Acceptable	
	Signature not in rectangle box		











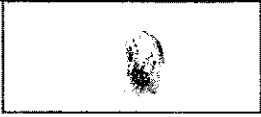













X		
	Signature not in full	
X		
	Initials are unacceptable	
X		
	Signature in Capital	
X		
	Signature is smaller in size. Instead of the box, entire page is scanned and uploaded.	
X		

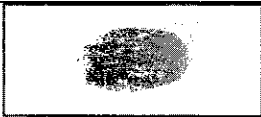



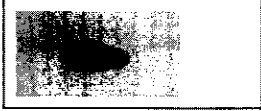

	<p>Signature not in plain white background</p>	
		
	<p>Signature and thumb impression in same box</p>	
		
	<p>Signatures with dark background</p>	
		
	<p>Signature outside the rectangle</p>	
		
	<p>Signature in other than blue or black ink</p>	
		

	Photograph uploaded in place of Signatures	
X		
	Thumb Impression Uploaded in place of Signatures	
X		

INSTRUCTIONS FOR ACCEPTABLE THUMB IMPRESSIONS

Not Acceptable Signature	Reason for Rejection	Acceptable
	Thumb impression in other than blue or black ink	
X		
	Thumb impression taken via mobile phone/camera with dark background	
X		

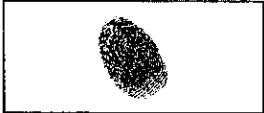
	Incomplete thumb impression	
		
	Picture of thumb impression	
		
	Thumb impression uploaded is partly cropped / not scanned completely.	
		
	Thumb impression is not clear	
		
	Dry thumb impression	
		
	Thumb impression not in plain white background	
		

	Thumb Impression obscured by too much ink.	
X		
	Thumb Impression is too small; upload full A4 size sheet instead of box alone	
X		

MINISTRY OF HEALTH AND FAMILY WELFARE

(Department of Health and Family Welfare)

NOTIFICATION

New Delhi, the 3rd August, 2016

S.O. 2672(E),-In exercise of the power conferred by sub-section (2) of section 11 of the Indian Medical Council Act, 1956 (102 of 1956), the Central Government after consulting the Medical Council of India, Hereby Makes the following further amendments in the First Schedule of the Act, namely;

- (i) The following diplomate National Board (DNB), Broad Specialty Courses (three years courses at the Post MBBS level) shall be inserted, namely,

Diplomate National Board (Anatomy)	This shall be recognised medical Qualification When granted by National Board of Examinations, New Delhi on or after August 1984.
Diplomate National Board (Emergency Medicine)	This shall be recognised medical Qualification When granted by National Board of Examinations in Medical Sciences, New Delhi on or after June, 2013.
Diplomate National Board (Field Epidemiology)	This shall be recognised medical Qualification When granted by National Board of Examinations in Medical Sciences, New Delhi on or after December 2012.
Diplomate National Board (Immunobematology & Transfusion Medicine)	This shall be recognised medical Qualification When granted by National Board of Examinations in Medical Sciences, New Delhi on or after December 2008.
Diplomate National Board (Rural Surgery)	This shall be recognised medical Qualification When granted by National Board of Examinations in Medical Sciences, New Delhi on or after December 2009.

- (ii) The following Diplomate National Board (DNB), Super Specialty Course (three years courses at the Post MD/MS level) shall be inserted, namely

Diplomate National Board (Endocrinology)	This shall be recognised medical Qualification When granted by National Board of Examinations, New Delhi on or after Feb 1989.
Diplomate National Board (Hematology)	This shall be recognised medical Qualification When granted by National Board of Examinations, New Delhi on or after December 2010.
Diplomate National Board (Medical Genetics)	This shall be recognised medical Qualification When granted by National Board of Examinations in Medical Sciences, New Delhi on or after January, 2015.

Diplomate National Board (Medical Oncology)	This shall be recognised medical Qualification When granted by National Board of Examinations in Medical Sciences, New Delhi on or after December 2002.
Diplomate National Board (Neonatology)	This shall be recognised medical Qualification When granted by National Board of Examinations in Medical Sciences, New Delhi on or after June 2005.
Diplomate National Board (Peripheral Vascular Surgery)	This shall be recognised medical Qualification When granted by National Board of Examinations in Medical Sciences, New Delhi on or after December 2009.
Diplomate National Board (Rheumatology)	This shall be recognised medical Qualification When granted by National Board of Examinations in Medical Sciences, New Delhi on or after December 2008.
Diplomate National Board (Surgical Gastroenterology)	This shall be recognised medical Qualification When granted by National Board of Examinations in Medical Sciences, New Delhi on or after January, 2002.
Diplomate National Board (Surgical Oncology)	This shall be recognised medical Qualification When granted by National Board of Examinations in Medical Sciences, New Delhi on or after December 2006.
Diplomate National Board (Thoracic Surgery)	This shall be recognised medical Qualification When granted by National Board of Examinations in Medical Sciences, New Delhi on or after January 2014.

(iii) The following Fellowship National Board (FNB), Courses (two years courses at the Post MD/MS level) Shall be inserted, namely,

Fellowship National Board (Critical care Medicine)	This shall be recognised medical Qualification When granted by National Board of Examinations, New Delhi on or after March 2001.
Fellowship National Board (Cardiac Anesthesia)	This shall be recognised medical Qualification When granted by National Board of Examinations in Medical Sciences, New Delhi on or after January, 2001.
Fellowship National Board (Hand & Micro Surgery)	This shall be recognised medical Qualification When granted by National Board of Examinations in Medical Sciences, New Delhi on or after February 2002.
Fellowship National Board (High, risk Pregnancy & Perinatology)	This shall be recognised medical Qualification When granted by National Board of Examinations in Medical Sciences, New Delhi on or after January 2001.
Fellowship National Board (Interventional Cardiology)	This shall be recognised medical Qualification When granted by National Board of Examinations in Medical Sciences, New Delhi on or after February 2002.
Fellowship National Board (Infectious Disease)	This shall be recognised medical Qualification When granted by National Board of Examinations in Medical Sciences, New Delhi on or after February 2008.

Fellowship National Board (Laboratory Medicine)	This shall be recognised medical Qualification When granted by National Board of Examinations in Medical Sciences, New Delhi on or after December 2006.
Fellowship National Board (Minimal Access Surgery)	This shall be recognised medical Qualification When granted by National Board of Examinations in Medical Sciences, New Delhi on or after December 2000.
Fellowship National Board (Pediatric Hemato Oncology)	This shall be recognised medical Qualification When granted by National Board of Examinations in Medical Sciences, New Delhi on or after December 2006.
Fellowship National Board (Pediatric Cardiology)	This shall be recognised medical Qualification When granted by National Board of Examinations in Medical Sciences, New Delhi on or after March 2001.
Fellowship National Board (Pediatric Intensive Care)	This shall be recognised medical Qualification When granted by National Board of Examinations in Medical Sciences, New Delhi on or after December 2006.
Fellowship National Board (Reproductive Medicine)	This shall be recognised medical Qualification When granted by National Board of Examinations in Medical Sciences, New Delhi on or after May 2003.
Fellowship National Board (Spine Surgery)	This shall be recognised medical Qualification When granted by National Board of Examinations in Medical Sciences, New Delhi on or after February 2001.
Fellowship National Board (Trauma Care)	This shall be recognised medical Qualification When granted by National Board of Examinations in Medical Sciences, New Delhi on or after May 2001.
Fellowship National Board (Vitreo Retinal Surgery)	This shall be recognised medical Qualification When granted by National Board of Examinations in Medical Sciences, New Delhi on or after March 2001.
Fellowship National Board (Paediatric Gastroenterology)	This shall be recognised medical Qualification When granted by National Board of Examinations in Medical Sciences, New Delhi on or after January 2014.
Fellowship National Board (Sports Medicine)	This shall be recognised medical Qualification When granted by National Board of Examinations in Medical Sciences, New Delhi on or after January 2014.

Note: - The FNB qualifications shall not be treated as a recognised medical qualification for the purpose of teaching faculty.

[No. V11025/19/2014-MEP]

ALIR. RIZVI, Jt. Secy.

No. V 11015/17/83-ME. (Policy)
GOVERNMENT OF INDIA MINISTRY OF HEALTH & FAMILY
WELFARE (DEPT. OF HEALTH)

New Delhi, Dated the 19th September, 1983

NOTIFICATION

S. O. In exercise of the power conferred by sub-section (2) of section (ii) of the Indian Medical Council Act, 1956 (102 of 1956), the Central Government after consulting the Medical Council of India, hereby makes the following further amendments in the First Schedule of the Act, namely:

(i) In the entries relating to National Board of Examinations in Medical Sciences, New Delhi after the entry Membership of National Academy of Medical Sciences (Microbiology) M.N.A.M.S. (micro) the following entries shall be inserted, namely:

Membership of the National Academy of Medical Science (Family Medicine)	M.N.A.M.S. (Family Medicine)
Membership of the National Academy of Medical Science (Biochemistry)	M.N.A.M.S (Biochemistry)
Membership of the National academy of Medical Science (Nuclear Medicine)	M.N.A.M.S (Nuclear Medicine)
Membership of the National Academy of the Medical Sciences (Clinical Pharmacology and therapeutics)	M.N.A.M.S (Clinical Pharmacology and therapeutics)

((ii) "The M.N.A.M.S. qualifications in various disciplines granted by the National Board of Examinations, New Delhi as included in this Schedule, shall be recognized medical qualifications only when granted on or before 30th August, 1982"

(iii) As a result of the change of nomenclature of the medical qualification granted by the National Board of Examinations in Medical Sciences, New Delhi, from M.N.A.M.S. (Membership of the National Academy of Medical Sciences) to Diplomate NB (Diplomate of National Board), in the entries relating to National Board of Examinations in Medical Sciences, New Delhi, after the foot note related to M.N.A.M.S. qualification, etc. following entries shall be inserted, namely:

"The Diplomate of National Board qualification in various disciplines granted by the National Board of Examination, New Delhi, shall be recognized medical qualifications when granted on or after 30th August 1982".

Diplomate National Board (Physiology) Diplomate N.B. (Phy)
Diplomate National Board (General Medicine) Diplomate N.B. (Gen Med)
Diplomate National Board (General Surgery) Diplomate N.B.(Gen Surg)
Diplomate National Board (Ophthalmology) Diplomate N.B. (Ophthal)
Diplomate National Board (Anesthesiology) Diplomate N.B. (Anaes)
Diplomate National Board (Social and Preventive Medicine) Diplomate N.B. (SPM)
Diplomate National Board (Paediatrics) Diplomate N.B. (Ped)
Diplomate National Board (Psychiatry) Diplomate N.B. (Psy)
Diplomate National Board (Orthopaedics) Diplomate N.B. (Ortho)
Diplomate National Board (Radio-diagnosis) Diplomate N.B. (Radio Dig)
Diplomate National Board (Radio Therapy) Diplomate N.B. (Radiotherapy)
Diplomate National Board (Health Administration including Hospital Administration) Diplomate N.B. (Health Administration including Hospital Administration)
Diplomate National Board (Oto-rhinolaryngology)Diplomate N.B. (Otorhino)
Diplomate National Board (Dermatology & Venereology) Diplomate N.B. (Derm & Vener)
Diplomate National Board (Obstetrics & Gynaecology) Diplomate N.B. (Obs & Gynae)
Diplomate National Board (Respiratory Diseases) Diplomate N.B. (Resp disease)
Diplomate National Board (Neuro Surgery) Diplomate N.B. (Neurosurgery)
Diplomate National Board (Paediatric Surgery) Diplomate N.B. (Ped Surg)
Diplomate National Board (Neurology) Diplomate N.B. (Neurology)
Diplomate National Board (Plastic Surgery) Diplomate N.B. (Plastic Surg)
Diplomate National Board (Genito-Urinary Surgery) Diplomate N.B. (Genitourinary Surg)
Diplomate National Board (Cardio-Thoracic Surgery)Diplomate N.B.(Cardiothoracic Surg)
Diplomate National Board (Physical Medicine Rehabilitation) Diplomate N.B. (Phy. Med & Rehab)
Diplomate National Board (Forensic Medicine) Diplomate N.B. (Forensic Med)
Diplomate National Board (Maternal Child Health) Diplomate N.B. (Maternal Child Health)
Diplomate National Board (Nephrology) Diplomate N.B. (Nephrology)
Diplomate National Board (Cardiology) Diplomate N.B.
(Cardiology)	
Diplomate National Board (Gastro-enterology) Diplomate N.B. (Gastro)
Diplomate National Board (Microbiology) Diplomate N.B. (Micro)
Diplomate National Board (Family Medicine) Diplomate N.B. (Family Medicine)
Diplomate National Board (Pathology) Diplomate N.B. (Pathology)
Diplomate National Board (Biochemistry) Diplomate N.B. (Biochemistry)
Diplomate National Board (Nuclear Medicine) Diplomate N.B. (Nuclear Med)
Diplomate National Board (Clinical Pharmacology and Therapeutics) Diplomate N.B. (Clinical Pharma and Therapeutic)

Sd/- (PC. Jain)
UNDER SECRETARY to the Govt. of India

To
The General Manager, Government of India Press, Mayapuri, Ring Road,
New Delhi

A/o. V11015/17/83-M.E. (P)

Copy forwarded for information

1. The Secretary, Medical Council of India Kotla Road, New Delhi
2. Dte. Gen. of Health Services, New Delhi
3. All State Government/ Union Territories.
4. Ministry of Law & Justice, Shastri Bhawan, New Delhi
5. National Medical Library, (to arrange 50 copies of Gazette Notifications)
6. The Secretary-cum-Registrar, National Board of Examinations in Medical Sciences, New Delhi

sd/- (PC. Jain)
UNDER SECRETARY

**List of Specialties in which DNB/DrNB Final Examinations
shall be conducted in June 2022 Session**

DNB- BROAD AND DrNB SUPER SPECIALTY COURSES:

1. Anatomy
2. Anaesthesiology
3. Biochemistry
4. Cardiac Anaesthesia
5. Cardiology
6. Cardio Vascular & Thoracic Surgery
7. Cardio Vascular & Thoracic Surgery (Direct 6 years course) (Part-1)
8. Clinical Hematology
9. Clinical Immunology and Rheumatology
10. Community Medicine
11. Critical Care Medicine
12. Dermatology, Venereology & Leprosy
13. Emergency Medicine
14. Endocrinology
15. Family Medicine
16. Field Epidemiology
17. Forensic Medicine
18. General Medicine
19. General Surgery
20. Hospital Administration
21. Immunohematology and Blood Transfusion
22. Medical Gastroenterology
23. Medical Genetics
24. Medical Oncology
25. Microbiology
26. Neonatology
27. Nephrology
28. Neuro Surgery
29. Neuro Surgery (Direct 6 years course) (Part-1)
30. Neurology
31. Neuro Anaesthesia

-
32. Nuclear Medicine
 33. Obstetrics and Gynaecology
 34. Ophthalmology
 35. Orthopaedics
 36. Otorhinolaryngology (ENT)
 37. Paediatric Surgery (Direct 6 years course) (Part-1)
 38. Paediatric Surgery
 39. Paediatrics
 40. Pathology
 41. Paediatric Cardiology
 42. Paediatric Critical Care
 43. Pharmacology
 44. Physiology
 45. Plastic & Reconstructive Surgery
 46. Plastic & Reconstructive Surgery (Direct 6 years course) (Part-1)
 47. Psychiatry
 48. Physical Medicine & Rehabilitation
 49. Radiation Oncology
 50. Radio Diagnosis
 51. Respiratory Medicine
 52. Rural Surgery
 53. Surgical Oncology
 54. Surgical Gastroenterology
 55. Thoracic Surgery
 56. Urology
 57. Vascular Surgery

DNB/DrNB Training Completion Certificate (Provisional)

Format of Training Completion Certificate to be furnished by all DNB/DrNB Candidates who have undergone training in institute accredited with NBEMS for DNB/DrNB training.

* *Submission of False/Fabricated information/documents shall be liable for penal action.*

NOTE: Ensure that DNB/DrNB training completion certificates MUST be issued on an OFFICIAL LETTERHEAD of the training hospital/institute under signature and stamp of Dean/ Principal/ Medical Superintendent/Head of the Institution/Director only, as per the prescribed format along with the leave records.

Office dispatch No.:

Date of issue:

To,
The Executive Director
National Board of Examinations in Medical Sciences
Medical Enclave, Ansari Nagar,
Mahatma Gandhi Marg (Ring Road)
New Delhi-110029

Candidate's
Photograph

Sub: Furnishing of DNB/DrNB Training Completion Certificate (PROVISIONAL)

Sir,

This training completion certificate has been issued to Dr _____ Son/ Daughter/ Wife of _____ who was registered with National Board of Examinations in Medical Sciences w.e.f _____ vide Registration Number _____ for Two/ Three years of DNB/DrNB training in the specialty of _____ in our hospital/institution, for the purpose of appearing in DNB/DrNB Final Examination.

It is hereby certified that:

1. He/She has joined the DNB/DrNB course on _____ and **WILL BE COMPLETING** mandatory Two/ Three years of training on _____.
2. The details of leave availed by the candidate till date are as follows:

Year of Training (First/ Second/ Third)	Period of Leave (Specify Dates of leave availed)	Nature of Leave	No. of Days
Total number of leave availed by the candidate during his/her DNB/DrNB training till date (Grand Total in Days)			

3. He/She has appeared in the Formative Assessments Test (FAT) conducted by NBEMS and the Internal Assessments conducted by our hospital/institution as per details mentioned below:

Year of Training (First/ Second/ Third)	Year of appearing in FAT conducted by NBEMS	Year of appearing in Internal Assessment conducted by the hospital

-
4. He/She has completed his/her thesis under supervision of an approved thesis guide and submitted his/her thesis for assessment to NBEMS on/before 28.02.2022.
 5. He/She has worked during his/her DNB/DrNB training as a resident doctor strictly in accordance with leave and other training guidelines of National Board of Examinations in Medical Sciences.

It is understood that if the details mentioned herein above are found at any stage to be incorrect/false/incomplete, he/she shall be declared INELIGIBLE for DNB/DrNB Final Examination and his/her candidature for the same shall stand cancelled and result, if any declared, shall be treated as null and void.

Yours sincerely,

Acknowledgement of the
candidate under his/her
Signature

Signature of Head of the Institution _____

Name & Designation _____

Official Stamp of the Issuing Authority with
Name, Designation and Institute

DrNB (D6Y) Training Completion Certificate (Provisional)

Format of Training Completion Certificate to be furnished by all DrNB (D6Y) Candidates who have undergone training in institute accredited with NBEMS for DrNB training.

* *Submission of False/Fabricated information/documents shall be liable for penal action.*

NOTE: Ensure that DrNB training completion certificates MUST be issued on an OFFICIAL LETTERHEAD of the training hospital/institute under signature and stamp of Dean/ Principal/ Medical Superintendent/Head of the Institution/Director only, as per the prescribed format along with the leave records.

Office dispatch No.:.....

Date of issue.....

To,
The Executive Director
National Board of Examinations in Medical Sciences
Medical Enclave, Ansari Nagar,
Mahatma Gandhi Marg (Ring Road)
New Delhi-110029

Candidate's
Photograph

Sub: Furnishing of DrNB (D6Y) Part I Training Completion Certificate (Provisional)

Sir,

This training completion certificate has been issued to Dr _____ Son/ Daughter/ Wife of _____ who was registered with National Board of Examinations in Medical Sciences w.e.f _____ vide Registration Number _____ for Six years of DrNB training in the specialty of _____ in our hospital/institution, for the purpose of appearing in DrNB (Direct 6 Years) Part I Examination.

It is hereby certified that:

1. He/She has joined the DrNB (Direct 6 Years) course on _____ and WILL BE COMPLETING mandatory Two years of training on _____.
2. The details of leave availed by the candidate till date are as follows:

Year of Training (First/ Second)	Period of Leave (Specify Dates of leave availed)	Nature of Leave	No. of Days
Total number of leave availed by the candidate during his/her DrNB training till date (Grand Total in Days)			

3. He/She has appeared in the Formative Assessments Test (FAT) conducted by NBEMS and the Internal Assessments conducted by our hospital/institution as per details mentioned below:

Year of Training (First/ Second)	Year of appearing in FAT conducted by NBEMS	Year of appearing in Internal Assessment conducted by the hospital

4. During these 2 years, the candidate has undergone DrNB training in basic principles of surgery and other allied departments as per applicable curriculum for DrNB Direct 6 years Programme, only at NBEMS/NMC recognized centres.
5. He/She has worked during his/her DrNB training as a resident doctor strictly in accordance with leave and other training guidelines of National Board of Examinations in Medical Sciences.

It is understood that if the details mentioned herein above are found at any stage to be incorrect/false/incomplete, he/she shall be declared INELIGIBLE for DrNB Direct 6 Year Par I Examination and his/her candidature for the same shall stand cancelled and result, if any declared, shall be treated as null and void.

Yours sincerely,

Acknowledgement of the candidate under his/her Signature

Signature of Head of the Institution _____

Name & Designation:

Official Stamp of the Issuing Authority with Name, Designation and Institute

DrNB (D6Y) Training Completion Certificate (Provisional)

Format of Training Completion Certificate to be furnished by all DrNB (D6Y) Candidates who have undergone training in institute accredited with NBEMS for DrNB training.

* *Submission of False/Fabricated information/documents shall be liable for penal action.*

NOTE: Ensure that DrNB training completion certificates MUST be issued on an OFFICIAL LETTERHEAD of the training hospital/institute under signature and stamp of Dean/ Principal/ Medical Superintendent/Head of the Institution/Director only, as per the prescribed format along with the leave records.

Office dispatch No.:

Date of issue:

To,
The Executive Director
National Board of Examinations in Medical Sciences
Medical Enclave, Ansari Nagar,
Mahatma Gandhi Marg (Ring Road)
New Delhi-110029

Candidate's
Photograph

Sub: Furnishing of DrNB (D6Y) Part II Training Completion Certificate (Provisional)

Sir,

This training completion certificate has been issued to Dr _____ Son/ Daughter/ Wife of _____ who was registered with National Board of Examinations in Medical Sciences w.e.f _____ vide Registration Number _____ for Six years of DrNB training in the specialty of _____ in our hospital/institution; for the purpose of appearing in DrNB (Direct 6 Year) Final (Part II) Examination.

It is hereby certified that:

1. He/She has joined the DrNB (Direct 6 Year) course on _____ and WILL BE COMPLETING mandatory Five years of training on _____.
2. The details of leave availed by the candidate till date are as follows:

Year of Training (1st/2nd/3rd/4th/5th)	Period of Leave (Specify Dates of leave availed)	Nature of Leave	No. of Days
Total number of leave availed by the candidate during his/her DrNB training till date (Grand Total in Days)			

3. He/She has appeared in the Formative Assessments Test (FAT) conducted by NBEMS and the Internal Assessments conducted by our hospital/institution as per details mentioned below:

Year of Training (1st/2nd/3rd/4th/5th)	Year of appearing in FAT conducted by NBEMS	Year of appearing in Internal Assessment conducted by the hospital

-
4. He/She has completed his/her thesis under supervision of an approved thesis guide and submitted his/her thesis for assessment to NBEMS on /before 28.02.2022.
 5. He/She has worked during his/her DrNB training as a resident doctor strictly in accordance with leave and other training guidelines of National Board of Examinations in Medical Sciences.

It is understood that if the details mentioned herein above are found at any stage to be incorrect/false/incomplete, he/she shall be declared INELIGIBLE for DrNB Final Examination and his/her candidature for the same shall stand cancelled and result, if any declared, shall be treated as null and void.

Yours sincerely,

Signature of Head of the Institution _____

Name & Designation _____

Acknowledgement of the
candidate under his/her
Signature

Official Stamp of the Issuing Authority
with Name, Designation and Institute

DNB/DrNB Training Completion Certificate (Final)

Format of Training Completion Certificate to be furnished by all DNB/DrNB Candidates who have undergone training in institute accredited with NBEMS for DNB/DrNB training.

* Submission of False/Fabricated information/documents shall be liable for penal action.

NOTE: Ensure that DNB/DrNB training completion certificates MUST be issued on an OFFICIAL LETTERHEAD of the training hospital/institute under signature and stamp of Dean/ Principal/ Medical Superintendent/Head of the Institution/Director only, as per the prescribed format along with the leave records.

Office dispatch No.:

Date of issue:

To,
The Executive Director
National Board of Examinations in Medical Sciences
Medical Enclave, Ansari Nagar,
Mahatma Gandhi Marg (Ring Road)
New Delhi-110029

Candidate's
Photograph

Sub: Furnishing of DNB/DrNB Training Completion Certificate (Final)

This training completion certificate has been issued to Dr _____ Son/ Daughter/ Wife of _____ who was registered with National Board of Examinations in Medical Sciences w.e.f _____ vide Registration Number _____ for Two/ Three years of DNB/DrNB training in the specialty of _____ in our hospital/institution, for the purpose of appearing in DNB/DrNB Final Examination.

It is hereby certified that:

1. He/She has joined the DNB/DrNB course on _____ and HAS COMPLETED mandatory Two/ Three years of training on _____.
2. The details of leave availed by the candidate till date are as follows:

Year of Training (First/ Second/ Third)	Period of Leave (Specify Dates of leave availed)	Nature of Leave	No. of Days
Total number of leave availed by the candidate during his/her entire DNB/DrNB training (Grand Total in Days)			

3. He/She has appeared in the Formative Assessments Test (FAT) conducted by NBEMS and the Internal Assessments conducted by our hospital/institution as per details mentioned below:

Year of Training (First/ Second/ Third)	Year of appearing in FAT conducted by NBEMS	Year of appearing in Internal Assessment conducted by the hospital

-
4. He/She has completed his/her thesis under supervision of an approved thesis guide and his/her thesis has been ACCEPTED by NBEMS vide acceptance letter dated _____.
 5. He/She has worked during his/her DNB/DrNB training as a resident doctor strictly in accordance with leave and other training guidelines of National Board of Examinations in Medical Sciences.

It is understood that if the details mentioned herein above are found at any stage to be incorrect/false/incomplete, he/she shall be declared INELIGIBLE for DNB/DrNB Final Examination and his/her candidature for the same shall stand cancelled and result, if any declared, shall be treated as null and void.

Yours sincerely,

Signature of Head of the Institution _____

Name & Designation _____

Acknowledgement of the
candidate under his/her
Signature

Official Stamp of the Issuing Authority with
Name, Designation and Institute

DrNB (D6Y) Training Completion Certificate (Final)

Format of Training Completion Certificate to be furnished by all DrNB (D6Y) Candidates who have undergone training in institute accredited with NBEMS for DrNB training.

* *Submission of False/Fabricated information/documents shall be liable for penal action.*

NOTE: Ensure that DrNB training completion certificates MUST be issued on an OFFICIAL LETTERHEAD of the training hospital/institute under signature and stamp of Dean/ Principal/ Medical Superintendent/Head of the Institution/Director only, as per the prescribed format along with the leave records.

Office dispatch No.:.....

Date of issue.....

To,
The Executive Director
National Board of Examinations in Medical Sciences
Medical Enclave, Ansari Nagar,
Mahatma Gandhi Marg (Ring Road)
New Delhi-110029

Candidate's
Photograph

Sub: Furnishing of DrNB (D6Y) Part I Training Completion Certificate (Final)

Sir,

This training completion certificate has been issued to Dr _____ Son/ Daughter/ Wife of _____ who was registered with National Board of Examinations in Medical Sciences w.e.f _____ vide Registration Number _____ for six years of DrNB training in the specialty of _____ in our hospital/institution, for the purpose of appearing in DrNB (Direct 6 Years) Part I Examination.

It is hereby certified that:

1. He/She has joined the DrNB (Direct 6 Years) course on _____ and **HAS COMPLETED** mandatory Two years of training on _____.
2. The details of leave availed by the candidate till date are as follows:

Year of Training (First/ Second)	Period of Leave (Specify Dates of leave availed)	Nature of Leave	No. of Days
Total number of leave availed by the candidate during his/her DrNB training till date (Grand Total in Days)			

3. He/She has appeared in the Formative Assessments Test (FAT) conducted by NBEMS and the Internal Assessments conducted by our hospital/institution as per details mentioned below:

Year of Training (First/ Second)	Year of appearing in FAT conducted by NBEMS	Year of appearing in Internal Assessment conducted by the hospital

-
4. During these 2 years, the candidate has undergone DrNB training in basic principles of surgery and other allied departments as per applicable curriculum for DrNB Direct 6 years Programme, only at NBEMS/NMC recognized centres.
 5. He/She has worked during his/her DrNB training as a resident doctor strictly in accordance with leave and other training guidelines of National Board of Examinations in Medical Sciences.

It is understood that if the details mentioned herein above are found at any stage to be incorrect/false/incomplete, he/she shall be declared INELIGIBLE for DrNB Direct 6 Year Part I Examination and his/her candidature for the same shall stand cancelled and result, if any declared, shall be treated as null and void.

Yours sincerely,

Acknowledgement of the
candidate under his/her
Signature

Signature of Head of the Institution _____

Name & Designation _____

Official Stamp of the Issuing Authority with
Name, Designation and Institute

DrNB (D6Y) Training Completion Certificate (Final)

Format of Training Completion Certificate to be furnished by all DrNB (D6Y) Candidates who have undergone training in institute accredited with NBEMS for DrNB training.

* *Submission of False/Fabricated information/documents shall be liable for penal action.*

NOTE: Ensure that DrNB training completion certificates MUST be issued on an OFFICIAL LETTERHEAD of the training hospital/institute under signature and stamp of Dean/ Principal/ Medical Superintendent/Head of the Institution/Director only, as per the prescribed format along with the leave records.

Office dispatch No.:.....

Date of issue:.....

To,
The Executive Director
National Board of Examinations in Medical Sciences
Medical Enclave, Ansari Nagar,
Mahatma Gandhi Marg (Ring Road)
New Delhi-110029

Candidate's
Photograph

Sub: Furnishing of DrNB (D6Y) Part II Training Completion Certificate (Final)

Sir,

This training completion certificate has been issued to Dr _____ Son/ Daughter/ Wife of _____ who was registered with National Board of Examinations in Medical Sciences w.e.f _____ vide Registration Number _____ for Six years of DNB/DrNB training in the speciality of _____ in our hospital/institution, for the purpose of appearing in DrNB (Direct 6 Year) Final (Part II) Examination.

It is hereby certified that:

1. He/She has joined the DrNB (Direct 6 Year) course on _____ and **HAS COMPLETED** mandatory Five years of training on _____
2. The details of leave availed by the candidate till date are as follows:

Year of Training (1st/2nd/3rd/4th/5th)	Period of Leave (Specify Dates of leave availed)	Nature of Leave	No. of Days
Total number of leave availed by the candidate during his/her DrNB training till date (Grand Total in Days)			

3. He/She has appeared in the Formative Assessments Test (FAT) conducted by NBEMS and the Internal Assessments conducted by our hospital/institution as per details mentioned below:

Year of Training (1st/2nd/3rd/4th/5th)	Year of appearing in FAT conducted by NBEMS	Year of appearing in Internal Assessment conducted by the hospital

-
4. He/She has completed his/her thesis under supervision of an approved thesis guide and his/her thesis has been ACCEPTED by NBEMS vide acceptance letter dated _____.
5. He/She has worked during his/her DrNB training as a resident doctor strictly in accordance with leave and other training guidelines of National Board of Examinations in Medical Sciences.

It is understood that if the details mentioned herein above are found at any stage to be incorrect/false/incomplete, he/she shall be declared INELIGIBLE for DrNB Final Examination and his/her candidature for the same shall stand cancelled and result, if any declared, shall be treated as null and void.

Yours sincerely,

Signature of Head of the Institution _____

Name & Designation _____

Acknowledgement of the
candidate under his/her
Signature

Official Stamp of the Issuing Authority with
Name, Designation and Institute

DrNB (D6Y) Training Completion Certificate (Final)

Format of Training Completion Certificate to be furnished by all DrNB (D6Y) Candidates who have undergone training in institute accredited with NBEMS for DrNB training.

+ Submission of False/Fabricated information/documents shall be liable for penal action.

NOTE: Ensure that DrNB training completion certificates MUST be issued on an OFFICIAL LETTERHEAD of the training hospital/institute under signature and stamp of Dean/ Principal/ Medical Superintendent/Head of the Institution/Director only, as per the prescribed format along with the leave records.

Office dispatch No.:.....

Date of issue.....

To,
The Executive Director
National Board of Examinations in Medical Sciences
Medical Enclave, Ansari Nagar
Mahatma Gandhi Marg (Ring Road)
New Delhi-110029

Candidate's
Photograph

Sub: Furnishing of DrNB (D6Y) Training Completion Certificate (Final)

Sir,

This training completion certificate has been issued to Dr _____ Son/ Daughter/ Wife of _____ who was registered with National Board of Examinations in Medical Sciences w.e.f _____ vide Registration Number _____ for Six years of DNB/DrNB training in the specialty of _____ in our hospital/institution, for the purpose of eligibility for DrNB (Direct 6 Year) Final (Part II) Examination.

It is hereby certified that:

1. He/She has joined the DrNB (Direct 6 Year) course on _____ and HAS COMPLETED mandatory Six years of training on _____.
2. The details of leave availed by the candidate till date are as follows:

Year of Training (1st/2nd/3rd/ 4th/5th/6th)	Period of Leave (Specify Dates of leave availed)	Nature of Leave	No. of Days
Total number of leave availed by the candidate during his/her entire DrNB training (Grand Total in Days)			

3. He/She has appeared in the Formative Assessments Test (FAT) conducted by NBEMS and the Internal Assessments conducted by our hospital/institution as per details mentioned below:

Year of Training (1st/2nd/3rd/ 4th/5th/6th)	Year of appearing in FAT conducted by NBEMS	Year of appearing in Internal Assessment conducted by the hospital

-
4. He/She has completed his/her thesis under supervision of an approved thesis guide and his/her thesis has been ACCEPTED by NBEMS vide acceptance letter dated _____.
 5. During the 6th year of training, the candidate has undergone supervised DrNB training and practice in the discipline of _____, only at NBEMS/NMC recognized centre(s), as per guidelines prescribed for DrNB Direct 6 year course curriculum.
 6. He/She has worked during his/her DrNB training as a resident doctor strictly in accordance with leave and other training guidelines of National Board of Examinations in Medical Sciences.

It is understood that if the details mentioned herein above are found at any stage to be incorrect/false/incomplete, he/she shall be declared INELIGIBLE for DrNB Final Examination and his/her candidature for the same shall stand cancelled and result, if any declared, shall be treated as null and void.

Yours sincerely,

Signature of Head of the Institution _____

Name & Designation _____

Acknowledgement of the
candidate under his/her
Signature

Official Stamp of the Issuing Authority
with Name, Designation and Institute

National Board of Examinations in Medical Sciences
Medical Enclave, Ansari Nagar,
Mahatma Gandhi Marg (Ring Road)
New Delhi- 110029

Candidate Helpline: 011 - 45593000 / 022-61087595
(Monday to Friday: 09:30AM to 06:00 PM)
Website: <https://natboard.edu.in>